

# Looking for something with a touch of elegance?

We can special order a large variety of doors, like the ones seen here and many others. Ask your sales representative for more information.

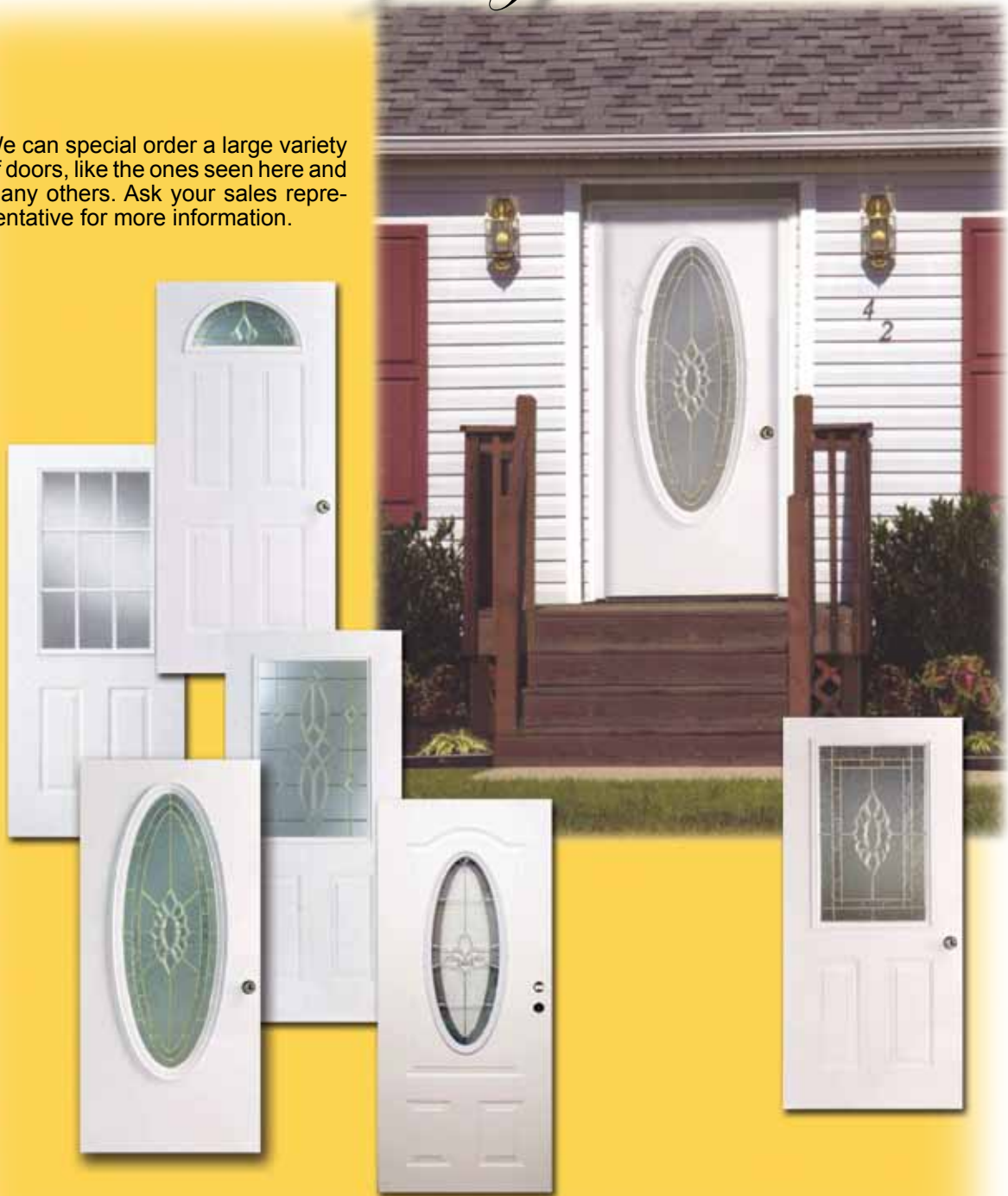

## Special Order Doors

# Taking Measurements For a Door:

There are many ways to measure for a door replacement, but Elixir recommends you measure your rough opening and select the replacement size which is closest to it.

For example, your rough opening measures 32-1/4" x 76-1/4". ALWAYS BACK DOWN TO THE NEAREST SIZE and order size 32" x 76".

To determine if your door is right or left handed, simply look at it from the outside of the home to see which side the hinges are on.

# Installing the Door:

1. Make certain all mounting surfaces (siding seams included) are securely fastened and flat around perimeter of door opening.
2. Apply a suitable non-hardening sealant tape (such as Elixir 10-B Mobile Seal) to the backside of the door's mounting flange.
3. Do not remove any shipping clips or fasteners and keep the door closed and locked during the installation. Opening the door prior to the installation will destroy the pre-squaring by the manufacturer.
4. Insert the door assembly carefully into the rough opening. Make certain the door sill is secure on the floor. Move door to hinge side until it is firmly against hinge side stud.
5. Proceed to fasten door with screws. Drive the first 3 screws into the outer frame in the middle at the hinge side. Then, drive the next 3 screws in the middle of the outer frame on the lock side. Then, secure the balance of the hinge side, across the sill, up the lock side and the header.
6. Remove the shipping clips and open the door. Install the appropriate hardware.
7. If it is a house-type door with storm door, make certain 2 long screws are put through the storm door plunger bracket fastened to the jamb. This is to anchor the bracket securely to your hinge side stud.
8. If the house-type inner door is secured to the outer frame with butt type hinges (steel six-panel door only), run one long screw through each hinge on the jamb side to penetrate the hinge side stud.
9. The house-type door has an adjustable stop. Adjust the stop to the exterior of the inner door to insure a good seal.

If the above steps are followed, the door will be sealed and operate properly.

**Steps 1, 2, 3 & 4**

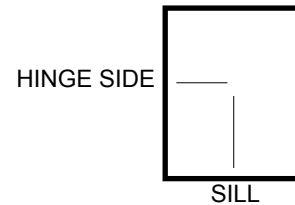

**Steps 5 & 6**

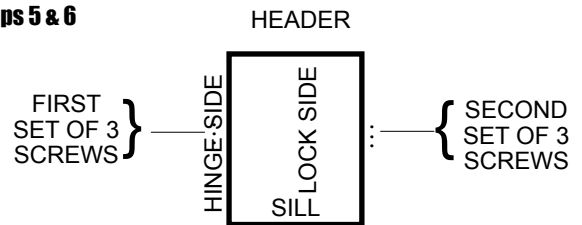

**Steps 6 & 7**

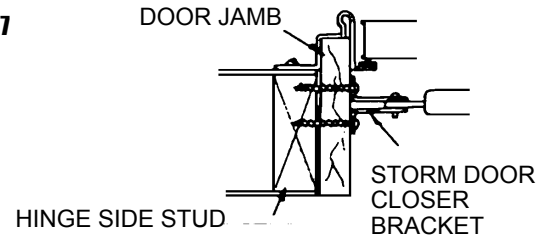

**Steps 8**

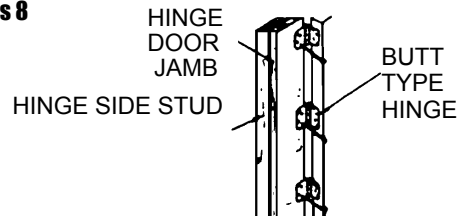

**Steps 9**

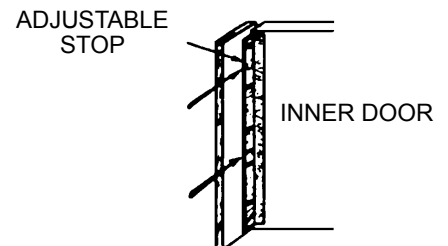

# Series 9000 Vinyl Steel Combo Door - Six Panel Style



Shown with all glass white storm and six-panel door

## Door Features:

### Vinyl Laminated Galvanized Steel

- Our Thickest Gauge of Long Lasting Steel
- Upgrade from Series 8000 Steel

### Double Seal

- Folded Steel Edge with Weather Stripping
- Lifetime Warranty Weather-Stripping
- Protects Against Air, Light and Water
- Easy Installation

### Polyurethane Foam Core

- Highly Energy Efficient R-Values

### Quality Wood Jambs

- Finger Jointed Solid Pine

### Three-Finger Vinyl Sweep

### Factory Installed Swivel Latch Bolt

Doors with windows below are drilled for deadbolt. All other stocked 6 panel doors have knocker, viewer and drilled for a dead bolt.



3/4 Oval Light Door



Six Panel Style						3/4 Oval Light	Fan Light	Fan Light
Jamb Width:	4"	4"	4"	4"	6.5"	4.5"	4"	4"
Door Inside:	White	White	White	White	White	White	White	White
Door Outside:	White	White	White	White	White	White	White	White
Storm Color:	White	White	Mill	White	White	White	White	White
Storm Style:	Full View All Glass	Full View	Standard	Standard	Standard	Full View All Glass	Standard	Full View All Glass
32 x 76	L/H				<b>0211131</b>	<b>0211216</b>		
	R/H				<b>0211132</b>	<b>0211217</b>		
34 x 76	L/H	<b>0211755</b>	<b>0211150</b> <b>0211153</b>	<b>0211121</b>	<b>0211122</b>	<b>0211140</b>	<b>0211761</b>	<b>0211757</b>
	R/H	<b>0211756</b>	<b>0211151</b> <b>0211152</b>	<b>0211120</b>	<b>0211123</b>	<b>0211141</b>	<b>0211760</b>	<b>0211758</b>
34 x 78	L/H		<b>0211154</b>		<b>0211144</b>		<b>0211752</b>	
	R/H		<b>0211162</b>		<b>0211145</b>		<b>0211747</b>	
34 x 80	L/H		<b>0211148</b>		<b>0211146</b>	<b>0211142</b>	<b>0211762</b>	
	R/H		<b>0211149</b>	<b>0211124</b>	<b>0211147</b>	<b>0211143</b>	<b>0211763</b>	
36 x 76	L/H	<b>0211160</b>						
	R/H	<b>0211161</b>						
36 x 80	L/H	<b>0211753</b>			<b>0211186</b>			
	R/H	<b>0211754</b>						
38 x 76	L/H		<b>0211163</b>					
	R/H		<b>0211164</b>					
38 x 80	L/H		<b>0211156</b>		<b>0211318</b>	<b>0211103*</b>		
	R/H		<b>0211157</b>		<b>0211319</b>	<b>0211102*</b>		
38 x 82	L/H		<b>0211158</b>					
	R/H		<b>0211159</b>					

\*6" Jams

Optional Hardware Sold on Page C-12

For storm door features, see page C-14

Outdoor Improvements  
Anchors & Set-Up Material  
Doors & Windows  
Coatings & Cleaners  
Appliances  
Tools & Hardware  
Carpet & Flooring  
Electrical  
Plumbing  
Towing & Safety  
Heating & Cooling

# Series 8000 Vinyl Steel Housetype Combination Door



(Pictured) Elegant white door with white standard storm door. Door is drilled for deadbolt.. 4" jambs. Other sizes and designs are available by special order.

### Vinyl Laminated Galvanized Steel

- Long Lasting
- 60% Thicker than Series 6000 Doors
- More Dent and Scratch Resistant

### Double Seal

- Folded Steel Edge with Weather Stripping
- Protects Against Air, Light and Water

### Adjustable Door Stop

### Three-Finger Vinyl Sweep

### Sloped Threshold

### Factory Installed Swivel Latch Bolt

### Polyurethane Foam Core

- Highly Energy Efficient R-Values

### Quality Wood Jambs

- Finger Jointed Solid Pine

**0210970** Fan Lite, 32" x 76" LH

**0210971** Fan Lite, 32" x 76" RH

**Optional Hardware Sold on Page C-12**

# Series STR 7000 Residential Vinyl Steel Combination Door Energy Rating

The Six panel and 4 panel STR Series 7000 Elixir Doors are Energy star rated to conform to the performance ratings in the chart below.



National Fenestration Rating Council



**ELIXIR INDUSTRIES**  
SINCE 1948

Entrance Door  
Product Lines  
ESB-M-1 Steel Entry Door

Product Description <sub>1</sub>	U-Factor/Solar Heat Gain Coefficient (SHGC)			
	1/4 Lite ≤ 410 in <sup>2</sup>	1/2 Lite ≤ 900 in <sup>2</sup>	3/4 Lite ≤ 1100 in <sup>2</sup>	Full Lite > 1100 in <sup>2</sup>
2/a1-D/na/air/0.764	0.22/0.12	0.29/0.24	0.32/0.29	0.36/0.37
2/a8-D/na/air/0.764	0.21/0.12	0.28/0.24	0.31/0.29	0.36/0.37
2/a8-D/na/air/0.514	0.21/0.12	0.28/0.24	0.31/0.29	0.35/0.37
2/a8-D/na/air/0.514 grids	0.21/0.12	0.28/0.23	0.31/0.27	0.36/0.34
2/a8-D/na/air/0.264	0.22/0.12	0.30/0.24	0.33/0.29	0.38/0.37
2/a8-D/na/air/0.264 grids	0.22/0.12	0.30/0.23	0.34/0.27	0.39/0.34
ESB-M-1 Embossed Door	0.14/0.01			
2/a1-D/na/air/0.764 grids	0.22/0.12	0.29/0.23	0.32/0.27	0.36/0.34
2/a8-D/na/air/0.764 grids	0.21/0.12	0.28/0.23	0.31/0.27	0.36/0.34
2/a8-D/na/air/0.514 grids	0.21/0.12	0.28/0.23	0.31/0.27	0.35/0.34
2/a1-D/0.204(2)/air/0.764 LE	0.20/0.10	0.26/0.20	0.28/0.24	0.31/0.31
2/a8-D/0.204(2)/air/0.764 LE	0.20/0.10	0.25/0.20	0.27/0.24	0.30/0.31
2/a8-D/0.204(2)/air/0.264 LE	0.21/0.10	0.27/0.20	0.29/0.24	0.33/0.31
2/a8-D/0.204(2)/air/0.264 LE Grd	0.21/0.10	0.28/0.19	0.30/0.23	0.34/0.29
2/a1-D/0.204(2)/air/0.764 LE Grd	0.20/0.10	0.26/0.19	0.28/0.23	0.31/0.29
2/a8-D/0.204(2)/air/0.764 LE Grd	0.20/0.10	0.25/0.19	0.27/0.23	0.30/0.29
2/a5-D/na/air/0.323 deco	0.20/0.11	0.25/0.22	0.27/0.26	0.30/0.33

Manufacturer stipulates that these ratings conform to applicable NFRC procedures for determining whole product performance. NFRC ratings are determined for a fixed set of environmental conditions and a specific product size. NFRC does not recommend any product and does not warrant the suitability of any product for any specific use. Consult manufacturers literature of other product performance information. [www.nfrc.org](http://www.nfrc.org)

<sub>1</sub> glazing layers / spacer type / lowE emissivity (surface) / gap fill / gap width

**NOTE:**

**Energy performance ratings are subject to change. For current ratings visit [www.energystar.gov](http://www.energystar.gov)**

# Series STR 7000 Residential Vinyl Steel Combination Door



Shown with full-view white storm door

**Decorative Fan Light Series 7000 Combo**



**Oval Frosted Series 7000 Combo**



4 Panel w/ Fan: sunburst window with beveled glass, floral pattern and brass caning replace top two panels.

Elegant white door with frosted oval window comes with brass kickplate and white all-glass storm door. Door is drilled for deadbolt. Entrance lock and deadbolt are available in brass. Keyed alike for convenience. 4.5" jamb. Other sizes and designs are available by special order. 0211210 & 0211211 shown above.



**ELIXIR**  
INDUSTRIES  
SINCE 1948

## Door Features:

### Vinyl Laminated Galvanized Steel

- Our Thickest Gauge of Long Lasting Steel
- Upgrade from Series 8000 Steel

### Lifetime Warranty Weather-Stripping

- Protects Against Air, Light and Water

### Residential 1-3/4" Door

- Our Very Best Door

### Polyurethane Foam Core

- Highly Energy Efficient R-Values

### Quality Wood Jamb

- Finger Jointed Solid Pine

### Six-Finger Vinyl Sweep

### Factory Installed Swivel Latch Bolt

## Series STR 7000 Residential Vinyl Steel Combination Door

		Six Panel Door*			4 Panel w/Fan*	Platinum Inlaid Oval	Frosted Glass Oval	9-Lite	
Jamb Width:		4"	4"	6.5"	4"			4"	6.5"
Door Inside:		White	White	White	White	White	White	White	White
Door Outside:		White	White	White	White	White	White	White	White
Storm Color:		White	White	White	White	White	White	White	White
Storm Style:		Full View	Standard	Standard	Full View	Full View	All Glass	Standard	White
34 x 76	L/H	<b>0211750</b>	<b>0211722</b>	<b>0211740</b>	<b>0211206</b>	<b>0211197</b>	<b>0211210</b>	<b>0211247</b>	<b>0211248</b>
	R/H	<b>0211751</b>	<b>0211723</b>	<b>0211741</b>	<b>0211205</b>	<b>0211198</b>	<b>0211211</b>	<b>0211246</b>	<b>0211249</b>
34 x 78	L/H								
	R/H								
34 x 80	L/H	<b>0211748</b>	<b>0211746</b>	<b>0211742</b>					
	R/H	<b>0211749</b>		<b>0211743</b>					

 \* Energy Star rated. (See chart on C-4)

# Series 6000 Housetype Combination Door

## Door Features:

- **Painted Galvanized Steel**  
Long Lasting
- **Double Seal**  
Folded Steel Edge with Weather Stripping  
Protects Against Air, Light and Water
- **Adjustable Door Stop**
- **Factory Installed Swivel Latch Bolt**
- **Sloped Threshold**
- **Polyurethane Foam Core**  
Highly Energy Efficient R-Values
- **Quality Wood Jambs**  
Finger Jointed Solid Pine

## 10" x 10" Diamond Series



10" x 10" Diamond (window) Series with Mill Finish Standard Storm Door.  
Details on page C-7

## Door Color Options:

**Exterior:** White or Cream  
**Interior:** White, Cream or Dark

Quality Wood Jambs



## Blank Style



Blank Style Door (no window) with White Standard Storm Door – Shown on Left.  
Details below.

**Optional Hardware Sold  
on Page C-12**

		<h3>Series 6000 Blank Style Combination Door</h3>				
Features		Knocker, Viewer & Deadbolt	Knocker & Viewer	Knocker & Viewer	Knocker & Viewer	Knocker, Viewer & Deadbolt
Outside:		White	White	White	White	White
Inside:		Dark	Dark	White	White	White
Storm Color:		Mill	White	Mill	White	White
Storm Style:		Standard Storm Door	Standard Storm Door	Standard Storm Door	Standard Storm Door	Standard Storm Door
32 X 76	L/H			<b>0211202</b>	<b>0212109</b>	
	R/H			<b>0211201</b>	<b>0212108</b>	
34 X 76	L/H	<b>0211098</b>	<b>0211106</b>	<b>0211219</b>	<b>0211207</b>	<b>0211091</b>
	R/H	<b>0211099</b>		<b>0211220</b>	<b>0211208</b>	<b>0211093</b>
34 x 80	L/H			<b>0211214</b>		
	R/H			<b>0211215</b>		

6000 Series		10" x 10" Diamond Window						Cottage Window		
Jamb Width:		4"	4"	4"	4"	4"	6.5"	6.5"	4"	6.5"
Outside:		White	White	White	White	White	White	White	White	White
Inside:		Dark	Dark	White	White	White	White	Dark	White	White
Storm Color:		White	Mill	Mill	White	White	White	Mill	White	White
Storm Style:		Standard	Standard	Standard	Standard	Full View	Standard	Standard	Standard	Standard
32 X 72	L/H		<b>0211051</b>	<b>0210870</b>	<b>0210880</b>					
	R/H		<b>0211052</b>	<b>0211056</b>	<b>0210881</b>					
32 X 74	L/H		<b>0210923</b>	<b>0210930</b>	<b>0212100</b>					
	R/H		<b>0210924</b>		<b>0212101</b>					
32 x 76	L/H	<b>0211079</b>	<b>0211065</b>	<b>0210872</b>	<b>0210874</b> <b>0212112**</b>			<b>0211118</b>		
	R/H	<b>0211078</b>	<b>0211066</b>	<b>0210873</b>	<b>0210875</b> <b>0212113**</b>			<b>0211119</b>		
32 x 78	L/H		<b>0211075</b>							
	R/H									
32 x 80	L/H				<b>0211308</b>					
	R/H				<b>0211309</b>					
34 x 76	L/H	<b>0211083</b>	<b>0211031</b>	<b>0210876</b>	<b>0210878</b> <b>0212110**</b>	<b>0210886</b>	<b>0211180</b> <b>0211091*</b>	<b>0211110</b>	<b>0211136*</b>	<b>0211167</b>
	R/H	<b>0211084</b>	<b>0211082</b>	<b>0210877</b>	<b>0210879</b> <b>0212111**</b>	<b>0210888</b>	<b>0211181</b>	<b>0211111</b>	<b>0211137*</b>	<b>0211166</b>
34 x 78	L/H	<b>0211088</b>	<b>0210911</b>	<b>0211300</b>	<b>0211304</b>			<b>0211112</b>	<b>0211138*</b>	
	R/H	<b>0211089</b>	<b>0210910</b>	<b>0211301</b>	<b>0211305</b>				<b>0211139*</b>	
34 x 80	L/H	<b>0211086</b>	<b>0211030</b>	<b>0211302</b>	<b>0211306</b>		<b>0211182</b>	<b>0211114</b>		<b>0211165</b>
	R/H		<b>0211090</b>	<b>0211303</b>	<b>0211307</b>		<b>0211183</b>	<b>0211115</b>		
36 x 76	L/H				<b>0210882</b>					
	R/H				<b>0210883</b>					
36 x 80	L/H		<b>0211116</b>	<b>0211312</b>	<b>0211311</b>					
	R/H		<b>0211117</b>	<b>0211313</b>	<b>0211310</b>					
38 x 76	L/H			<b>0211316</b>	<b>0212106</b>					
	R/H			<b>0211317</b>	<b>0212107</b>					
38 x 80	L/H					<b>0210928</b>	<b>0211101*</b>			
	R/H					<b>0210929</b>	<b>0211100*</b>			

\* With knocker/viewer, deadbolt bore

\*\* With deadbolt bore

For storm door features,  
see page C-14



**ELIXIR**  
INDUSTRIES  
SINCE 1948

## 6000 Series Fan Window

Classic white door with fan-shaped window is white inside and out with matching white jambs. Drilled for deadbolt.

- 0210914** 34" x 76" LH; Full View White Storm
- 0210915** 34" x 76" RH; Full View White Storm
- 0210917** 34" x 76" LH; Std. White Storm
- 0210921** 34" x 76" RH; Std. White Storm
- 0211233** 34" x 76" LH; Std. White Storm with 4.5" Jambs
- 0211234** 34" x 76" RH; Std. White Storm with 4.5" Jambs



# Series 400 Vinyl Steel Exterior Door

## Door Features:

### Vinyl Laminated Galvanized Steel

- Long Lasting
- 60% Thicker than Series 200 Doors
- More Dent and Scratch Resistant
- Withstands Winds in Excess of 140 MPH

### Double Seal

- Folded Steel Edge with Weather Stripping
- Protects Against Air, Light and Water

### Factory Installed Swivel Latch Bolt

### Polyurethane Foam Core

- Highly Energy Efficient R-Values

### Adjustable Striker Plates



Fan Window



Series 400, LH Door (shown above) w/ Cottage Window

## Door w/Fan Window

**0210960** 34" x 76" LH White/White w/Dead Bolt Bore

**0210961** 34" x 76" RH White/White w/Dead Bolt Bore



## Door w/Cottage Window

**0210976** 36" x 80" LH White/White, Mill Frame, (shown at right)



## Door w/10" X 10" Diamond Window

**0210965** 32" x 74" LH White/White

**0210966** 36" x 80" LH Gray/Gray

**0210967** 36" x 80" RH Gray/Gray

**0210968** 36" x 80" RH White/White

**0210969** 36" x 80" LH White/White



## Door w/10" x 10" Square Window

**0210819** 34" x 72" LH White/White w/Mill Finish Door Frame

**0210959** 34" x 72" RH White/White w/Mill Finish Door Frame

## Blank Door Series 400, (No Window)

**0210964** 36" x 80" LH White/White, White Frame

**0210978** 36" x 80" LH White/White, Mill Frame (shown at right)

**0210973** 32" x 74" LH White/White, Mill Frame

## Fiberglass Extra Wide Single Door

Often used for portable buildings.

**0211171** 60" x 72" LH White/White, Mill Frame



Blank, Series 400, LH Door



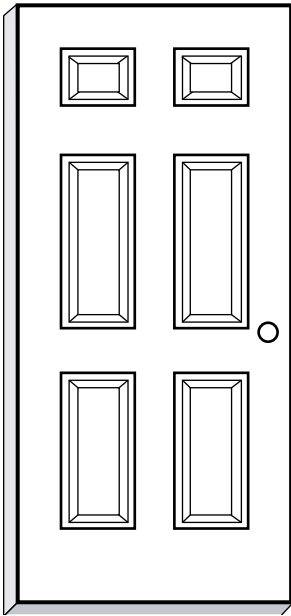

## Series 300 6-Panel

Same quality features as the 400 Series with six raised panels. White door and frame only.

- 0211126** 32" x 72" LH, knocker, viewer
- 0211127** 32" x 76" RH, knocker, viewer
- 0211128** 32" x 76" LH, knocker, viewer
- 0210758** 34" x 76" LH, knocker, viewer, deadbolt bore
- 0211129** 34" x 76" RH, knocker, viewer
- 0211130** 34" x 76" LH, knocker, viewer
- 0210787** 34" x 76" LH, deadbolt bore
- 0210788** 34" x 76" RH, deadbolt bore
- 0211107** 36" x 80" RH



Specially designed for manufactured home doors, tested residential grade. Locks are sold without bolts and strike plate, which are included in our stocked doors.

- 0295040** Entrance Lock, Stainless Steel
- 0295030** Entrance Lock, Stainless Steel, Keyed to #0122544
- 0295041** Entrance Lock & Deadbolt Set, Master Keyed, Stainless Steel.



## Reinforced Commercial Grade

Commercial Grade with 2 x 4 Construction

### BLANK DOORS

- 0211175** 36" x 80" LH Blank White/White
- 0211176** 36" x 80" RH Blank White/White (*shown on the right*)

### HEAVY DUTY LOCK

- 0295005** Round Knob, Stainless Steel
- 0295006** Lever Style, Stainless Steel

### THRESHOLD FOR HANDICAP ENTRANCE

- 0265491** Interior For 36" Door
- 0265492** Exterior For 36" Door

## Series 100, Double Doors

Same quality features as Series 200, but with double doors. See following pages for features of 200 series doors.

### Blank Double Door

Mill Finish Frame

- 0211172** 61" x 72", RH, White/Dark
- 0211212** 61" x 72", LH, White/White
- 0211155** 61" x 80", LH, White/White
- 0211170** 72" x 72", RH, White/White
- 0211168** 72" x 72", RH, White/Dark
- 0211169** 72" x 72", LH, Cream/Cream
- 0211279** 72" x 72", RH, Buck/Buck
- 0211173** 72" x 80", LH, White/White

### Cottage Double Door

White/White Mill Finish Frame

- 0211213** 72" x 76," LH

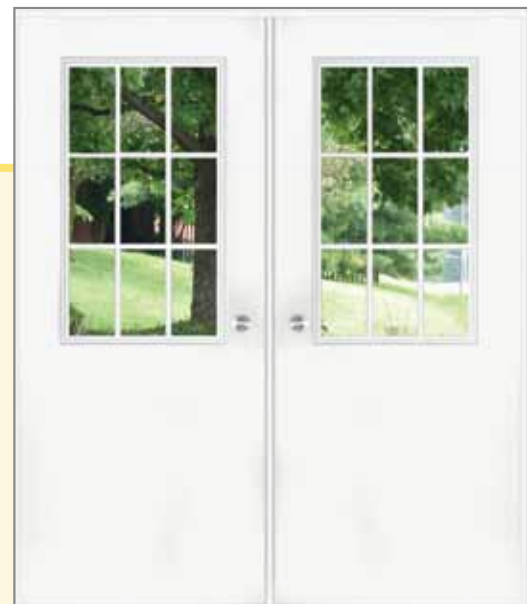

# Series 200 Manufactured Home Exterior Door



## Door Features:

### Painted Galvanized Steel

- Long Lasting

### Double Seal

- Folded Steel Edge w/Weather Stripping
- Protects Against Air, Light and Water

### Factory Installed Swivel Latch Bolt

### Polyurethane Foam Core

- Highly Energy Efficient R-Values

### Adjustable Striker Plates

## Door Color Options:

**Exterior:** White or Cream

**Interior:** White, Cream or Dark

## Frame Color Options:

White, Cream or Bronze

## Quick Reference For Door Hardware

Hardware is sold as an option on these doors for economy, so you can buy only what you need.

- 0295040** Lock, Stainless Steel\*
- 0295041** Deadbolt Combo SS, Master-Keyed\*
- 0212022** Knocker/Viewer, Brass
- 0212010** Knocker/Viewer, Chrome
- 0265506** Threshold f/32" or less
- 0265507** Threshold f/34" door
- 0265508** Threshold f/36" door
- 0265509** Threshold f/48" door
- 0265510** Threshold f/72" door
- 0219001** Weather Stripping 30'
- 0212011** Drip Cap f/32" or smaller door
- 0212012** Drip Cap f/34" door
- 0212013** Drip Cap f/36" door
- 0212014** Drip Cap f/48" door
- 0212018** Drip Cap f/53" door
- 0212009** Drip Cap f/72" door
- 0210601** Safety Chain Kit
- 0210602** S Hooks
- 0210455** Replacement Door Shipping Clip

\* These items come without a bolt or strike, which are already installed on these doors

Specially designed for manufactured home doors, tested residential grade. Locks are sold without bolts and strike plate, which are included in our stocked doors.

- 0295040** Entrance Lock, Stainless Steel
- 0295030** Entrance Lock, Stainless Steel, Keyed to #0122544
- 0295041** Entrance Lock & Deadbolt Set, Master Keyed, Stainless Steel.



**ELIXIR INDUSTRIES**  
SINCE 1948

# Series 200 Exterior Doors

		10" x 10" Diamond Window			18" x 20" Slider Window			Cottage Window		Fan Window
OUTSIDE:		White	White	White	White	White	White	White	White	White
INSIDE:		Dark	White	White	Dark	White	White	White	White	White
		MF Frame	WH Frame	MF Frame	MF Frame	WH Frame	MF Frame	WH Frame	MF Frame	WH Frame
30 x 72	LH	<b>0211035</b>	<b>0210866</b>		<b>0210800</b>					
	RH		<b>0210867</b>		<b>0210799</b>					
32 x 72	LH	<b>0210916</b>	<b>0210850</b>		<b>0210801</b>	<b>0211400</b>	<b>0211846</b>	<b>0210885</b>		
	RH	<b>0210920</b>	<b>0210849</b>	<b>0211800</b>	<b>0210802</b>	<b>0211401</b>		<b>0210884</b>		
32 x 74	LH	<b>0211033</b>	<b>0212102</b>		<b>0210810</b>	<b>0211402</b>		<b>0211410</b>		
	RH	<b>0210935</b>	<b>0212103</b>		<b>0210812</b>	<b>0211403</b>		<b>0211411</b>		
32 x 76	LH	<b>0210919</b>	<b>0210854</b> <b>0211803*</b>	<b>0211802</b> <b>0211804*</b>	<b>0210806</b>	<b>0211404</b>	<b>0211850</b>	<b>0210887</b>	<b>0211878</b>	<b>0210847</b>
	RH	<b>0210797</b>	<b>0210855</b>	<b>0211805</b>	<b>0210798</b>	<b>0211405</b>	<b>0211851</b>	<b>0210896</b>	<b>0211879</b>	<b>0210848</b>
32 x 78	LH	<b>0210897</b>	<b>0210912</b>	<b>0211806</b>	<b>0210901</b>	<b>0211406</b>		<b>0211412</b>		<b>0210894</b>
	RH	<b>0210936</b>	<b>0210913</b>	<b>0211807</b>	<b>0210902</b>	<b>0211407</b>		<b>0211413</b>		<b>0210895</b>
32 x 80	LH		<b>0210926</b>	<b>0211808</b>	<b>0210908</b>	<b>0211408</b>		<b>0210946</b>	<b>0211882</b>	
	RH		<b>0210927</b>			<b>0211409</b>	<b>0211855</b>	<b>0210947</b>	<b>0211883</b>	
34 x 72	LH									
	RH			<b>0210821**</b>						
34 x 76	LH	<b>0210918</b>	<b>0210858</b> <b>0211028*</b>	<b>0211812</b>	<b>0211029</b>	<b>0210840</b>	<b>0211858</b>	<b>0210889</b>	<b>0211886</b>	<b>0210856</b> <b>0211027*</b>
	RH	<b>0210904</b>	<b>0210859</b>	<b>0211813</b>	<b>0210905</b>	<b>0210841</b>	<b>0211859</b>	<b>0210890*</b>	<b>0211887</b>	<b>0210857</b>
34 x 78	LH	<b>0210898</b>	<b>0210862</b>	<b>0211814</b>	<b>0210899</b>	<b>0210842</b>	<b>0211860</b>	<b>0210891</b>	<b>0211888</b>	<b>0210938</b>
	RH		<b>0210863</b>			<b>0210843</b>		<b>0210892</b>	<b>0211889</b>	<b>0210939</b>
34 x 80	LH	<b>0210903</b>	<b>0210864</b>	<b>0211816</b>	<b>0210909</b>	<b>0210844</b>	<b>0211862</b>			
	RH		<b>0210865</b>	<b>0211817</b>		<b>0210845</b>	<b>0211863</b>			
36 x 72	LH							<b>0210893</b>		
	RH									
36 x 76	LH		<b>0210868</b>	<b>0211820</b>					<b>0210861</b>	
	RH		<b>0210869</b>	<b>0211821</b>		<b>0210837</b>			<b>0210853</b>	
36 x 80	LH	<b>0210814</b>	<b>0210816</b>	<b>0210796</b>	<b>0210906</b>	<b>0210838</b>		<b>0210851</b>		
	RH	<b>0210833</b>	<b>0210817</b>	<b>0211822</b> <b>0210822**</b>	<b>0210907</b>	<b>0210839</b>	<b>0211871</b>	<b>0210852</b>		

\*With Deadbolt Drill

\*\*Square 10" x 10" Window

## Diamond Replacement Window 10" x 10"



**0210745** 10" x 10" Diamond Window, Brown

**0210747** 10" x 10" Diamond Window, White



**ELIXIR**  
INDUSTRIES  
SINCE 1948

# Series 200 Exterior Doors

## Blank

OUTSIDE:	White	White	White	Cream	White	Buck
INSIDE:	Dark	White	White	Dark/Buck	Buck	Buck
	MF Frame	WH Frame	MF Frame	MF Frame	MF Frame	MF Frame
30 x 72	<b>0210804</b>	<b>0211179</b>	<b>0211900</b>			
32 x 72	<b>0210805</b>	<b>0210790</b>	<b>0211187</b>			
32 x 74	<b>0210786</b>	<b>0211178</b>	<b>0211901</b>			
32 x 76	<b>0210811</b>	<b>0210791</b> <b>0211826*</b>	<b>0211827</b>	<b>0210823</b>		
32 x 78	<b>0210780</b>	<b>0210781</b>	<b>0211828</b>			
32 x 80		<b>0210835</b>	<b>0211829</b>			
34 x 76	<b>0210809</b>	<b>0210807</b> <b>0211833*</b> <b>0211832**</b>	<b>0211835</b>	<b>0210824</b>		
34 x 78	<b>0210779</b>	<b>0210792</b>	<b>0211836</b>			
34 x 80		<b>0210793</b>	<b>0211837</b>			
36 x 60			<b>0211190</b>			
36 x 61			<b>0211196</b>			
36 x 63			<b>0211193</b> <b>0211272 H</b>			
36 x 70			<b>0211192</b>			
36 x 72	<b>0210775</b>		<b>0211189</b> <b>0211273 H</b>			
36 x 74			<b>0211194</b>			
36 x 76	<b>0210776</b>	<b>0210774</b>	<b>0211840</b>			
36 x 80	<b>0210789</b>	<b>0210794</b>	<b>0211841</b> <b>0211270 H</b>	<b>0210828</b>		
48 x 63			<b>0210785</b>			
48 x 72	<b>0210778</b>		<b>0210782</b>	<b>0210777 B</b>		<b>0210761</b>
48 x 76	<b>0210768</b>		<b>0210783</b>			
48 x 80			<b>0210784</b>	<b>0210766</b>	<b>0210767</b>	

\* Left Hand, With Deadbolt Drill

\*\* Left Hand, Knocker Viewer with Deadbolt Drill

H - Heavy Duty Frame

B - Buck Color

## Quick Reference For Door Hardware

Hardware is sold as an option on these doors for economy, so you can buy only what you need.

<b>0295040</b>	Lock, Stainless Steel*	<b>0219001</b>	Weather Stripping 30'
<b>0295041</b>	Deadbolt Combo SS, Master-Keyed*	<b>0212011</b>	Drip Cap f/32" or smaller door
<b>0212022</b>	Knocker/Viewer, Brass	<b>0212012</b>	Drip Cap f/34" door
<b>0212010</b>	Knocker/Viewer, Chrome	<b>0212013</b>	Drip Cap f/36" door
<b>0265506</b>	Threshold f/32" or less	<b>0212014</b>	Drip Cap f/48" door
<b>0265507</b>	Threshold f/34" door	<b>0212018</b>	Drip Cap f/53" door
<b>0265508</b>	Threshold f/36" door	<b>0212009</b>	Drip Cap f/72" door
<b>0265509</b>	Threshold f/48" door	<b>0210601</b>	Safety Chain Kit
<b>0265510</b>	Threshold f/72" door	<b>0210602</b>	S Hooks
		<b>0210455</b>	Replacement Door Shipping Clip

\* These items come without a bolt or strike, which are already installed on these doors

# Replacement Windows for Doors

## Diamond Window 10" x 10"



**0210745** Brown  
**0210747** White

## Long Rectangular Window



4" x 24" Window,  
Colorless Obscure Glass  
w/White Frame

**0210746**

## Fan Window



**0210750** White Fan Window

## Cottage Window



**0210744** 20" x 36"  
**0210740** 22" x 36"

## Exterior Door Hinges

### Door Hinges



**0210608** Mill Ext.  
**0210609** White

## Slider Window



18" x 20" w/Screen  
**0210803** Mill Finish  
**0210795** White

## Exterior Door Hinges for 7000 Series Doors

Designed with Radius  
Corners For The 7000  
Series Doors.



**0210605** Zinc

## Six Finger Hinges

Six screw flanges.

**0210993** Satin Nickel

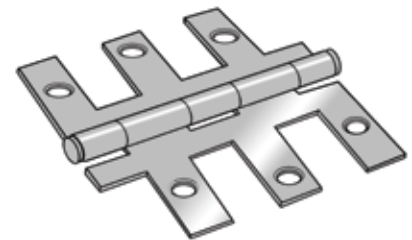

## Combo Door Hinges

Designed for 6000, 8,000  
and 9,000 Series Doors.

**0210995** Brass  
**0210996** Zinc



Outdoor Improvements  
Anchors & Set-Up Material  
Doors & Windows  
Coatings & Cleaners  
Appliances  
Tools & Hardware  
Carpet & Flooring  
Electrical  
Plumbing  
Towing & Safety  
Heating & Cooling

		 <h1>Storm Doors</h1>				
Rough Opening		Mill	White	Bronze	White	White
		Standard	Standard	Standard	Full View	All Glass
32 x 72	LH	<b>0210808</b>	<b>0212104</b>			
	RH	<b>0210815</b>	<b>0212105</b>			
32 x 76	LH	<b>0211006</b>	<b>0211007</b>	<b>0211059</b>		
	RH	<b>0210818</b>	<b>0211008</b>	<b>0211060</b>		
34 x 76	LH	<b>0211020</b>	<b>0211053</b>	<b>0211055</b>	<b>0211133</b>	<b>0211023</b>
	RH	<b>0211013</b>	<b>0211054</b>	<b>0211061</b>	<b>0211134</b>	<b>0211024</b>
34 x 78	LH	<b>0211012</b>	<b>0211062</b>		<b>0211135</b>	
	RH	<b>0211015</b>	<b>0211058</b>			
34 x 80	LH	<b>0211010</b>	<b>0211064</b>			<b>0211021</b>
	RH	<b>0211014</b>	<b>0211063</b>			<b>0211022</b>
36 x 76	LH		<b>0211043</b>			
	RH		<b>0211044</b>			
36 x 80	LH		<b>0211050</b>			
	RH		<b>0211041</b>			
38 x 76	LH		<b>0211045</b>			
	RH		<b>0211046</b>			
38 x 80	LH		<b>0211017</b>			
	RH		<b>0211016</b>			
38 x 82	LH		<b>0211048</b>			
	RH		<b>0211049</b>			



All storm doors pictured are right-hand doors.

Heavy-gauge, hollow, aluminum door frame, reinforced with 14-gauge corner gussets. Fiberglass screen resists impact without permanent deformation.

Sliding window tested in 2,500 uses without failure (equivalent to more than 20 years of normal use). 1/8" tempered safety glass installed in all standard size doors.

Other sizes and styles available by special order. Note: Hardware is Not included.

## Replacement Screen Window

for Standard Storm Door  
27" x 29"



- 0210945** Screen f/Std. Door - Mill Finish
- 0210948** Screen f/Std. Door - White

## Hardware Kits

Handle & Closure Kit

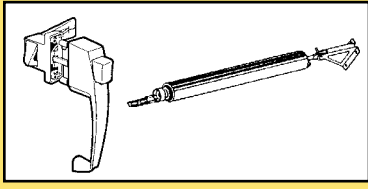

- 0212036** Black
- 0212038** White

## Storm Door Parts

- 0210450** Top Glides for Bottom Glass
- 0210452** Clips & Springs for Bottom Glass
- 0210470** Clip for Full View Storm, White
- 0295085** Hinge - Mill
- 0295086** Hinge - White
- 0295087** Hinge - Brass

## Pushbutton Latch Handle

- Anti-lockout feature
- 1-3/4" mounting hold spacing
- Installs in three 1/4" holes
- Carded

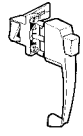

For all outswinging doors 7/8" to 1-1/4". Converts to key locking set with key plug.

- 0291300** White; 5/Ctn.
- 0291301** Aluminum; 10/Ctn.
- 0291302** Black; 10/Ctn.

## Storm Door Closer

Smooth, silent regulated closing for storm and screen doors. Permanently sealed tube. Positive-latching mechanism. Shock absorber action.



- 0210700** White
- 0210701** Aluminum
- 0210702** Black

## Pushbutton Key Plug

for Storm Door Locks

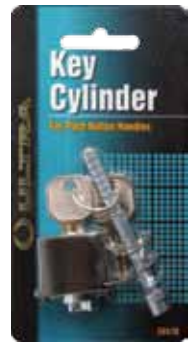
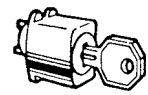

Fits most rectangular pushbutton storm doors. Furnished with calibrated metal spindle and spring.

- 0291305** Black; 10/Ctn.

# Sliding Glass Patio Doors by *Kimro*

## Vinyl

- Attractive low profile multi-chambered frame increases viewing area and improves thermal and sound insulating value.
- Standard Frame for use with all wall/siding types. Lap Frame with integral siding pocket that eliminates the need for additional siding trim pieces.
- Heat fusion welded frame and moving panel provides superior structural strength and prevents potential leakage at the corners.
- Staggered internal weep system allows minimum dust infiltration. Snap-in weep covers are standard.
- 3/4 inch sealed insulating glass (tempered) with "intercept" spacer and optional Low-E provides optimum thermal performance.
- Color coordinated attractive mortise type keyed lock mounted on steel reinforced lock jamb for strength and sturdiness that provides added security. Lock keeper is adjustable.
- Easy to reverse the door from XO to OX or OX to XO. Reversing must be done prior to installation.



**0212029** "OX"  
**0212028** "XO"  
**0212030** Screen for vinyl door

**0290403** Replacement Lock

Meets or exceeds the performance requirement of - AAMA 1701.2 Standard, Grade Wind Zone III AAMA/NWDA 101 / 1.5.2 Standard, Grade SGD-R15



**XO:** From outside looking in, left panel slides, right panel is stationary.  
**OX:** From outside looking in, right panel slides, left panel is stationary.

### VINYL TECHNICAL SPECIFICATIONS

CALL WIDTH	NET FRAME SIZE (inches)	RECOMMENDED ROUGH OPENING (inches)
6'-0"	71 1/2	72
8'-6"	95 1/2	96

CALL Height	NET FRAME SIZE (inches)	RECOMMENDED ROUGH OPENING (inches)
6'-4"	75 1/2	76
6'-8"	79 1/2	80

## Aluminum

**For Flush Mount Applications, 72" W x 76" H, White Aluminum (Buck size: 71<sup>15/16</sup>" x 76.5)**

- Standard Frame for use with all wall/siding types. Lap Frame with integral siding pocket that eliminates the need for additional siding trim pieces.
- 5/8 inch sealed insulating glass (tempered) with optional Low-E provides optimum thermal performance.
- Heavy duty fin seal weatherstrip to reduce air, water, dust and noise infiltration.
- Fully adjustable factory lubricated steel tandem rollers mounted with ball bearing insures trouble free operation.
- Full length lip on lock jamb acts as lock strike, not requiring adjustments after the door is properly installed.
- Slide direction easily reversed from XO to OX or OX to XO.



**XO:** From outside looking in, left panel slides, right panel is stationary.  
**OX:** From outside looking in, right panel slides, left panel is stationary.

**0212044** "XO" with 15/15 grids  
**0212045** "OX" with 15/15 grids  
**0212034** Screen for alum. door  
**0212026** "OX"  
**0212025** "XO"  
**0290402** Replacement Lock

### ALUMINUM TECHNICAL SPECIFICATIONS

CALL WIDTH	NET FRAME SIZE (inches)	RECOMMENDED ROUGH OPENING (inches)
5'-0"	58 15/16	59 1/4
5'-6"	64 15/16	65 1/4
6'-0"	70 15/16	71 1/4

CALL Height	NET FRAME SIZE (inches)	RECOMMENDED ROUGH OPENING (inches)
6'-0"	72 1/2	72 3/4
6'-4"	76 1/2	76 3/4
6'-8"	80 1/2	80 3/4

Minimum size that meets HUD 3280.105 egress requirement would be 5'-6" x 6'-4"

## Outswinging Double French Doors

Add value and beauty to the home with Double French Doors.

These are part of the Series 400 Exterior Doors featured on page C-8. Please refer to that page for construction details and features.



**0212040** 72" x 76" RH  
**0212041** 72" x 76" LH

## Sliding Patio Door Lock

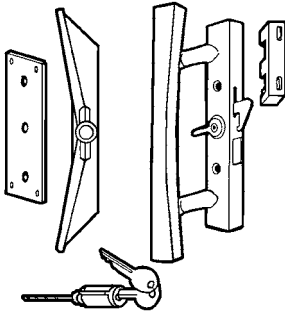

Universal sliding glass door lock features extended guide to prevent lift and opening. Also guarantees lock alignment. Fits most doors.

- 0290405** Patio Door Lock (Old Style)
- 0290406** Patio Door Lock (New Style) for Vinyl Doors
- 0290407** Lock Cylinder Only

## Sliding Patio Door Lock Kit

Universal, recessed sliding door lock kit, with key, comes with easy to follow instructions. (Found on 1999 and older homes.)

**0290408**

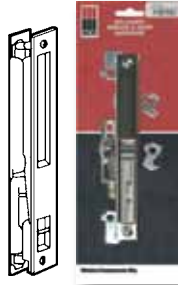

## Replacement Patio Screen Door

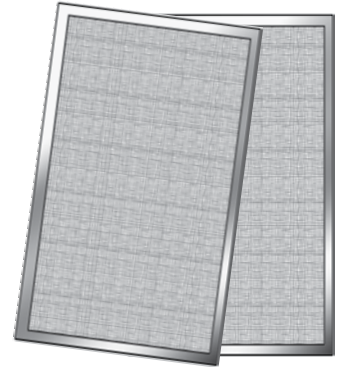

For Phillips Style M/1000 Screen Door, 36" x 75-7/16"

- 0212007** Mill Finish
- 0212008** White

For Kinro:

- 0212030** Vinyl Patio Door
- 0212034** Aluminum Patio Door

## Nite Lock Pin

For Sliding Patio Door

Protects against burglary. Easy installation. Out of children's reach.

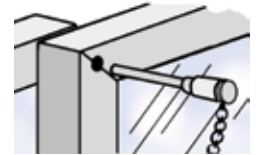

**0469000**

## Patio Screen Roller #197C



**0461702** 12/Ctn.

## Tacky Tape®

Tacky Tape® is designed to seal and prevent the entry of dust, air and moisture and assure a weather tight seal. Weatherability: QUV, 340A lamp (1000 Hrs, Excellent, no cracking, chalking, wash-off or flow (sag). 3/4" x 1/8" x 30'.

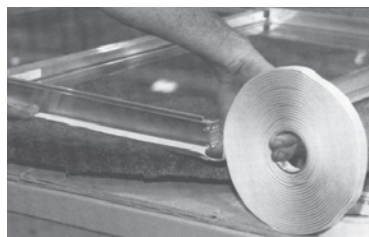

**0360800** 24/Ctn.

C-16

## Patio Door Roller

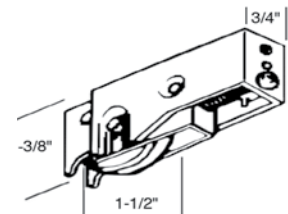

**0461703**



# 1-3/8" Interior Doors

## Six-Panel Masonite Molded Doors:

The Masonite Molded Panel Series is the industry benchmark for all composite wood doors. This series utilizes a composite wood construction that results in a more durable door that resists warping, shrinking, and cracking better than a solid wood door. In harvest oak or classic white. Uses non-mortise hinges.



### Standard Doors:

The Masonite® Veneer Flush interior door offers the visual beauty and refinement of natural wood doors at a value price. These doors are available as hollow core or solid core for the weight and feel of solid wood. Veneer Flush doors are both stainable or paintable.



## Interior Doors

	Standard		Six Panel Molded	
	Valley Oak	Flushed White	Harvest Oak	White
24" x 78"	<b>0210710</b>	<b>0210715</b>	<b>0210687</b>	<b>0210705</b>
24" x 80"	<b>0210729</b>	<b>0210725</b>	<b>0210680</b>	<b>0210735</b>
26" x 78"	<b>0210711</b>	<b>0210716</b>	<b>0210688</b>	<b>0210706</b>
26" x 80"	<b>0210730</b>	<b>0210726</b>	<b>0210681</b>	<b>0210736</b>
28" x 78"	<b>0210712</b>	<b>0210717</b>	<b>0210689</b>	<b>0210707</b>
28" x 80"	<b>0210731</b>	<b>0210727</b>	<b>0210682</b>	<b>0210737</b>
30" x 78"	<b>0210713</b>	<b>0210718</b>	<b>0210690</b>	<b>0210708</b>
30" x 80"	<b>0210732</b>	<b>0210728</b>	<b>0210683</b>	<b>0210738</b>
32" x 78"	<b>0210721</b>	<b>0210720</b>	<b>0210691</b>	
32" x 80"	<b>0210743</b>	<b>0210742</b>	<b>0210684</b>	<b>0210734</b>
36" x 78"	<b>0210714</b>			
36" x 80"	<b>0210741</b>	<b>0210739</b>		

All Colors May Not Be Available At All Locations • Other colors available by special order.

## Interior Passage & Privacy Lock



Conical knob, contemporary design. 2-3/8" round drive-in latch.

- 0290105** Passage, Polished Brass
- 0290106** Privacy, Polished Brass
- 0290103** Passage, Brushed Nickel
- 0290104** Privacy, Brushed Nickel

Other interior locks are sold on page 20

Privacy

## Interior Door Hinges

Non-mortise, 3 leaf folding door hinges, 1-3/16" x 3-7/16".



Polybagged in pairs with 8 screws.

- 0210990** Brass
- 0210991** Brushed Nickel

Non-mortise, extended, 3 leaf folding door hinges. 1-3/16 x 3-7/16 (extended leaf 1-1/2")

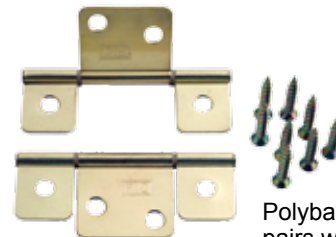

Polybagged in pairs with 8 screws.

- 0210989** Brass
- 0210992** Brushed Nickel

Non-Mortise Hinge

2/Box

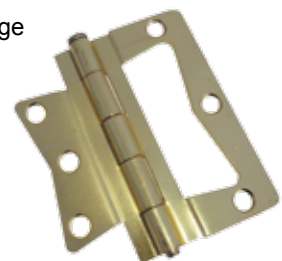

- 0210998** Brass

Outdoor Improvements  
 Anchors & Set-Up Material  
 Doors & Windows  
 Coatings & Cleaners  
 Appliances  
 Tools & Hardware  
 Carpet & Flooring  
 Electrical  
 Plumbing  
 Towing & Safety  
 Heating & Cooling

**LOCWARE** by

**ELIXIR INDUSTRIES**  
 SINCE 1948

**Entrance Lock Only**

- Seamless one-piece knob
- Auto-release and panic-proof
- Patented revolving collar adj. drive-in latch bolt for easy installation



**0295046** Master-keyed, Adj. Stainless Steel

**0295077** Master-keyed, Adj., Brass

**0295068** Mortise Plate

**0295059** Replacement Key for Master-Keyed Locks

**Deadbolt Lock Only**



- Solid brass cylinder housing
- Patented revolving collar drive-in latch bolt for easy installation
- Solid brass latchbolt with anti-sawing roller insert
- 2-3/8 Backset

**0295054** Single, Stain. Steel

**0295078** Single Deadbolt, Brass

**0295079** Double Deadbolt, Brass

**LOCWARE**  
**Combo Lock Sets**



Keyed-alike entrance and deadbolt lock set. Great security, specially designed for manufactured home doors, tested residential grade. Adjustable bolts, single deadbolt.

**0295125** Brass

**0295126** Stainless Steel

**Elixir Deadbolt Drive-In Latch Bolt**

2-3/8" drive-in w/swivel bolt.  
 5/8" Throw



**0295032** 12/Ctn.

**0295061** Patented revolving collar adj. drive-in latch bolt for easy installation

**Elixir Entrance Drive-In Latch Bolt**



Adjustable swivel latch bolt only. Slides from 2-3/8" backset to 2-3/4".

**0295050** 24/Ctn.

**ELIXIR INDUSTRIES**  
 SINCE 1948  
**Striker Plates**

**0295065** For Elixir Entrance Lock (Doors produced prior to Aug. 1992)

**0295066** For Elixir Dead Bolt Lock (Doors produced prior to Aug. 1992)

**0295070** For Elixir Regular Doors

**0295071** For House-type (Combo) Doors



**Elixir Key**



**0295060** Blank

**0295059** Master Key



# Exterior Door Lock & Deadbolt



0290811 Shown

## Drive-In Entrance Lock

2-1/8" diameter face hole, 1" diameter latch hole. Comes with adjustable round, drive-in latch bolt. 20/Ctn.

**0290827** Stainless Steel

**0290828** Master-keyed Stainless Steel, #69777

**0290812** Bright Brass

**0290813** Master-keyed Bright Brass, #69777

## Combo Set

Single deadbolt and entry knob keyed alike in a single box. Adjustable drive-in latch.

**0290810** Bright Brass

**0290825** Stainless Steel

## Square Latch Bolt Entrance Lock

2-1/8" diameter face hole, 1" diameter latch hole. Comes with adjustable square latch bolt. 20/Ctn.

**0290826** Stainless Steel

**0290811** Bright Brass

## Drive-In Bolt

Drive-in dead latch adjustable back set replacement bolt.



**0290819** Stainless Steel

## Master Key

Fits EZSET entrance lock with drive-in latch bolt. Master-keyed. #69777.



**0290818**

## Strike Plate



### Interior Door



Standard latch for 1/2" projection dead bolt. 24/Ctn.

**0290817** Bright Brass

**0290820** Stainless Steel

### QUALITY

- All metal construction
- All exposed components are brass or stainless steel
- Nickel plated brass key

### SECURITY

- 5 Pin tumbler cylinder
- Solid brass cylinder core
- Adjustable 2-3/8" to 2-3/4" backset dead latch on entrance function

### CONVENIENCE

- Cylinder removable for rekeying
- Reversible for RH/LH door
- Adjustable for 1-3/8" to 1-3/4" door thickness
- 2-3/8" to 2-3/4" adjustable backset
- Easy installation
- Can be keyed alike with any E-Z Set lockset



## E-Z Set Deadbolt Lock

1-1/2" to 2-1/8" diameter door face hole. 1" diameter latch hole. 1" projection. 20/Ctn.

**0290816** Double Bright Brass

**0290831** Double Stainless Steel

**0290815** Single Bright Brass

**0290830** Single Stainless Steel

## Economy Entrance Lock & Deadbolt

Adjustable backset bolt.

**0295055** Combo Set, Stainless Steel

**0295076** Entrance Lock, Brass

**0295019** Entrance Lock, Stainless Steel

**0295020** Deadbolt, Stainless Steel

**0295021** Deadbolt, Brass



Outdoor Improvements  
 Anchors & Set-Up Material  
 Doors & Windows  
 Coatings & Cleaners  
 Appliances  
 Tools & Hardware  
 Carpet & Flooring  
 Electrical  
 Plumbing  
 Towing & Safety  
 Heating & Cooling

Outdoor Improvements  
 Anchors & Set-Up Material  
 Doors & Windows  
 Coatings & Cleaners  
 Appliances  
 Tools & Hardware  
 Carpet & Flooring  
 Electrical  
 Plumbing  
 Towing & Safety  
 Heating & Cooling

# Exterior Door Locks, Supplies and Tools



0290805 Knob/Knob

## Valterra Entrance Locks

Adjusts to fit 2-3/8" or 2-3/4" backset and standard or drive-in style latches. Eliminates the guesswork in determining which lock is needed for replacement. Stainless steel finish. Panic-proof knob always free to open. Rekeyable.



0295039 Knob/Lever

- 0290805 Knob/Knob
- 0295039 Knob/Lever



## Theft Stopper

Allows you to easily repair damage from break-ins without replacing entire door, and protects against a recurrence.

Just three easy steps: remove screws from doorknob, place Theft Stopper on outside of door, then replace the knob.

0212024

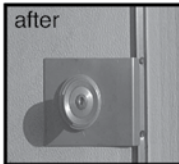
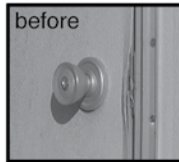

## Powerbolt Keyless Lockset

Electronic touchpad single-cylinder deadbolt for residential entries.



0290611 Satin Nickel

## Door Viewer

One-way viewer, zinc die-cast with 180° angle plastic lens. 9/16" diameter viewer adjusts for door thicknesses 1-1/2" to 2-1/2". Installation hole is 9/16". Display boxed.



0212017 Chrome

## Knocker Viewer



- 0212010 Stainless Steel
- 0212012 Brass

## Lock Installation Tool Kit



## Hole Saw

For fast and easy installation of most locksets and deadbolts; fits most popular electric and cordless drills. Blade-mandrel and bit are high quality heat treated and hardened. Contains one 2-1/8" diameter high carbon steel high speed holesaw and mandrel, and one 1" high speed wood power bit. Will saw through metal or wood. Carded.

0390500 12/Ctn.

# Interior Door Locks and Supplies

## Conical Passage & Privacy Lock



Passage



Privacy

Conical knob, contemporary design. 2-3/8" round drive-in latch.

- 0290105** Passage, Polished Brass; 30/Ctn.
- 0290106** Privacy, Polished Brass; 30/Ctn.
- 0290107** Replacement Bolt, Polished Brass
- 0290103** Passage, Brushed Nickel; 30/Ctn.
- 0290104** Privacy, Brushed Nickel; 30/Ctn.

## Lever Passage & Privacy Lock



Passage



Privacy

- 0290110** Passage, Polished Brass
- 0290111** Privacy, Polished Brass
- 0290112** Passage, Brushed Nickel
- 0290113** Privacy, Brushed Nickel

## Interior Decorator Plastic Lock

For doors 1" to 1-1/2" thick. Will not rust, tarnish or corrode. 2-3/8" backset, 7/8" diameter. Standard full lip strike.

Smooth-turning. Shrink packaged. 50/Ctn.

- 0291901** Privacy, Coffee
- 0291900** Privacy, Almond
- 0291700** Passage, Almond
- 0291701** Passage, Coffee



## Self-Adhesive Door Stop



- 0211002** White; 100/Ctn.

## Spring-Eze Stop



Flexible brass-plated steel spring with white plastic tip. 3" long.

- 0211004** 200/Ctn.

## Knob/Wall Protector

High impact material can be painted or papered. Foam on back absorbs shock. 1/4" total thickness. Washable. White.

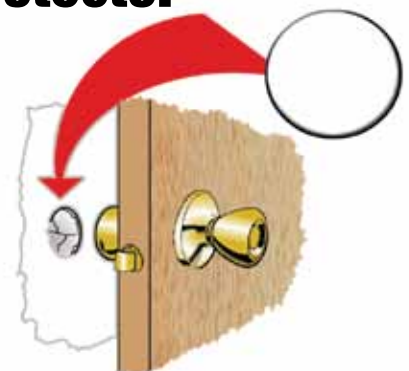

- 0211003** 3" Dia.
- 0211005** 5" Dia.

## "S" Hook

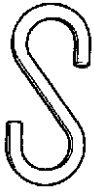

Approximately 1-1/2" Long. Ideal for chain door connections and many other uses.

**0210602**

## Door Clip



Keeps doors closed and secure during transport or whenever you need to restrict access.

**0210455**

## Weather Stripping

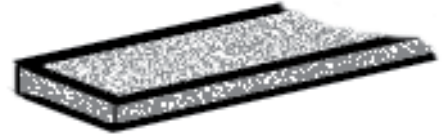

**0219001** 30' Weather Stripping

## Adjustable Vinyl Door Bottom

Fills gap between the door and door bottom to prevent air, dust and water entry. Additional seal at top stops any water seepage. Pre-punched slotted holes and self-tapping screws. 36" long. 24/Ctn.

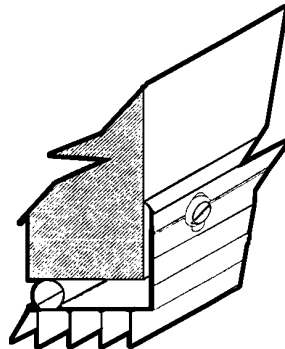

**0219010** White  
**0219011** Brown

## Roof Edge

Extra soft, heavy-gauge with standard edge. Fourteen ft. length punched with 4" centers.

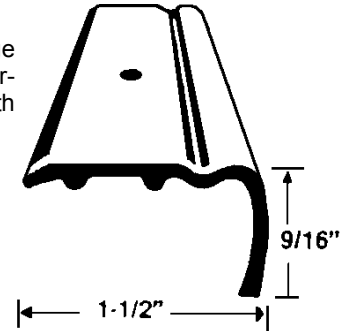

**0265501** 24/Ctn.

## Aluminum Molding Drip Rail

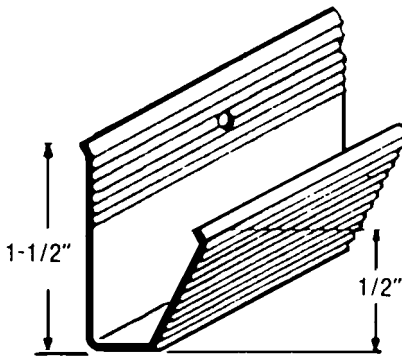

Serrated face 1-1/2" standard 1-1/2" rail 14' length w/punched 4" centers.

**0265503** 25/Ctn.

## Elixir Drip Cap

Install over doors and windows to channel away rain and snow. Steel with white finish.



**0212009** For 72" door  
**0212011** For 32" or less door  
**0212012** For 34" door  
**0212013** For 36" door  
**0212014** For 48" door  
**0212018** For 53" door

## Drip Cap

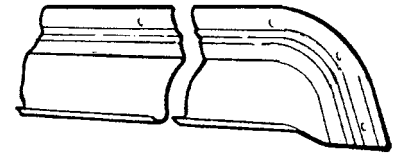

Install over doors and windows to channel away rain and snow. The confined caulking area insures neat appearance and positive seal.

**0210950** 31"  
**0210951** 35"  
**0210953** 39"  
**0210954** 43"  
**0210955** 49"

## Door Sweep

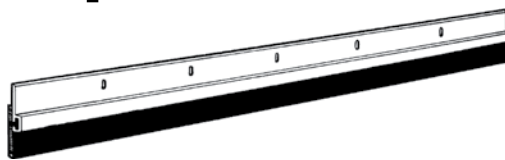

1-1/2" overall width including vinyl. 37" overall length. Satin finish. Poly-bag.

**0219009** 24/Ctn.

## Elixir Threshold

Constructed of aluminum.

**0265506** F/32" or less door  
**0265507** F/34" door  
**0265508** F/36" door  
**0265509** F/48" door  
**0265510** F/72" door

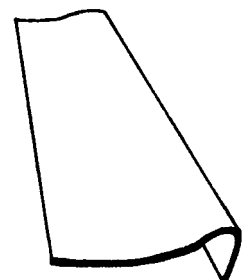

# Weather Stripping

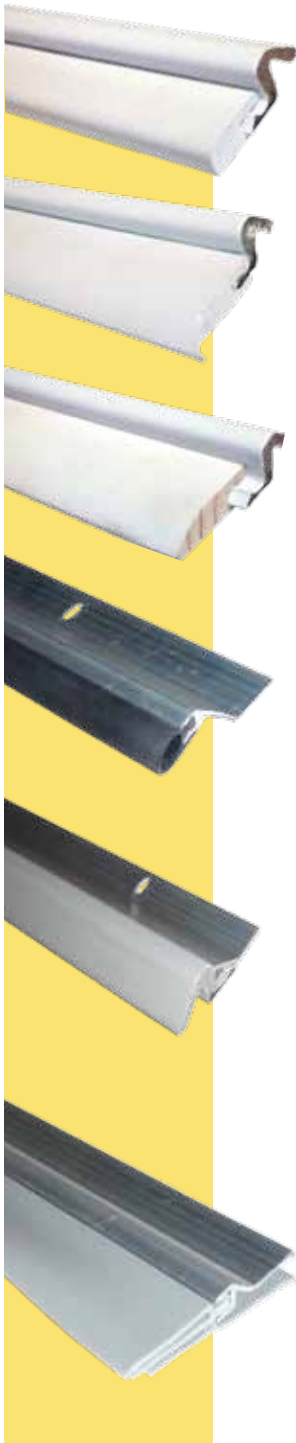

## Visco Door Weather Stripping

**Construction:** Pine wood strip or PVC, available as 1<sup>3</sup>/<sub>8</sub>" or 3<sup>4</sup>/<sub>4</sub>" Quarter Round, Narrow.

**Insert:** Q-Lon soft cell foam insert. Foam has thermoplastic cover and will not deteriorate.

**Finish:** White foam (Brown can be special ordered). Wood is primed, PVC is white.

**Lengths:** 1-3' piece and 2-7' pieces.

**0219015** PVC, 3<sup>4</sup>/<sub>4</sub>", White, Narrow

**0219016** PVC, 1<sup>3</sup>/<sub>8</sub>", White, Quarter Round

**0219017** Wood - 1<sup>3</sup>/<sub>8</sub>", Primed, Quarter Round

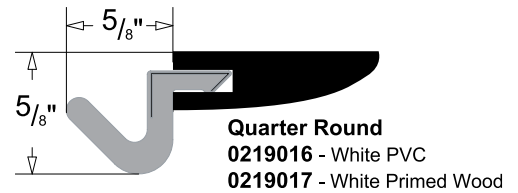
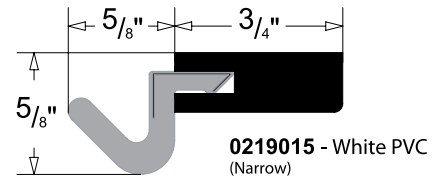

## Visco Heavy Duty (Low Profile) Door Weather Stripping

**Construction:** Extruded aluminum. Mitered corners ensure a secure fit with slotted mounting holes for easy adjustment.

**Insert:** 1/4" flexible, bubble type neoprene.

**Finish:** Aluminum (Brown or white can be special ordered).

**Set:** 1-3' piece and 2-7' pieces. Custom lengths also available.

**0219019** Mitered Aluminum  
Approved for sound abatement program.

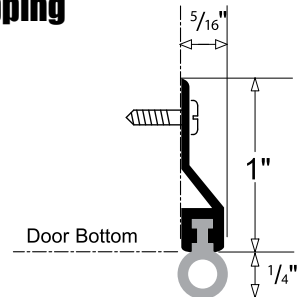

## Visco Door Weather Stripping

**Construction Q-Lon:** Extruded aluminum. Mitered corners ensure a secure fit with slotted mounting holes for easy adjustment.

**Insert:** Soft cell foam insert. Foam has thermoplastic cover and will not deteriorate.

**Finish:** Aluminum, brown or white finish.

Custom lengths also available.

**Set:** 1-3' piece and 2-7' pieces. Custom lengths also available.

**0219018** Mitered Aluminum

**0219020** Mitered White

**0219021** Mitered Brown

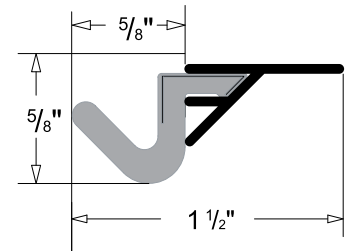

## Visco Door Triple Sweep

**Construction:** Extruded Aluminum

**Insert:** 3/4" Vinyl Insert

**Finish:** Aluminum

**Lengths:** 36"

(Additional sizes and colors available by special order.)

**0219025** Aluminum

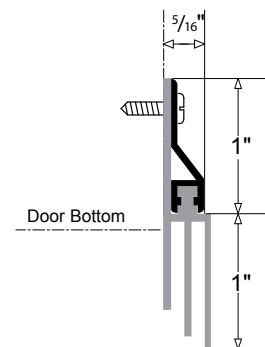

## Frost King Replacement Door Seal for Kerfed Millwork Doors

Thermoset plastic door seal will replace the seal in doors with standard 1/8" x 11/32" kerfs. Superior resistance to low temperature compression and will fill gaps up to 11/16". An eliminator seal Unconditionally guaranteed never to fail.

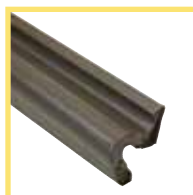

**0219005** Brown; Threshold; Vinyl Covered Foam.

## Frost King 1" x 7' White Vinyl Clad Foam Kerf Door Seal

White foam to match Door Jambs Foam encased in Vinyl for durability best weatherseal for Kerfed Doors Weatherproof and Water Resistant.



**0219006** White; Window; Vinyl Covered Foam.