

Double Disc Anchor with 4" & 6" Disc



Shaft: 3/4", Length: 36",
Discs: 6" & 4"

Recommended for Soil Class 4

0120019 6/Bundle; 180/Skid

0121019 6/Bundle; 180/Skid,
Galvanized



0120019

Single Disc Anchors



Earth anchor with disc and double fastening and tensioning head.

Recommended for Soil Class 4

With 6" Disc

0120000 48" L, 5/8" Shaft; 6/Bundle, 180/Skid

0120003 48" L, 3/4" Shaft; 6/Bundle, 180/Skid

0120001 36" L, 3/4" Shaft; 6/Bundle, 180/Skid

With 8" Disc

0120020 60" L, 3/4" Shaft; Each

Galvanized Single Disc

0120400 48" L, 5/8" Shaft Galv., 6" Disc, 6/Bdl.

0120401 48" L, 3/4" Shaft Galv., 6" Disc, 6/Bundle, 180/Skid

0120402 60" L, 3/4" Shaft Galv., 8" Disc, 6/Bundle, 180/Skid



0120003

ZipCap Anchor Stabilizer



Easy to install; screws into ground with anchor when you use a ZIPCAP adapter. Saves money; you don't need to stock two types of anchors. Saves space; packaged 8 to a box for easy transport. Better performance; free-floating ZIPCAP doesn't move when anchor pulls vertically.

More flexibility; approved for soil class 2 & 3 with 0120004 and soil class 4 with 0120019.

0120050 HP34 & HP3 3/4" x 30" Anchor, 4" Discs,
150/Skid (F/Class 3)

0120051 HP34 & HP17 3/4" x 36" Anchor, 6" Discs,
110/Skid (F/Class 4)

0120029 Electric Anchor Adapter for Zip Cap



0120050

Double Disc Anchors



Double 4" disc earth anchor with double fastening and tensioning head for use with straps. Designed to be augured into extremely hard soil where 6" disc anchor will not suffice. Two 4" discs. 200/Skid; 8/Bundle.

Recommended for Soil Classes 2 & 3

0120004 30" L, 3/4" Shaft;
8/Bundle, 200/Skid

0121004 Same as 0120004,
but Galvanized

0120008 30" L, 5/8" Shaft;
8/Bundle, 200/Skid

0120011 48" L, 3/4" Shaft

0120012 42" L, 3/4" Shaft

0121012 Same as 0120012, but Galvanized



0120004

Minute Man anchors, Inc.

E-Z Anchors

Save time and money with one-step stabilized anchors for decks and steps. Easy to install, needs no concrete. Built-in stabilizer head and compacting disk, pitched dual blades. **Approved for use in Alabama for Class 3 Soil.**

0120025 3/4" Shaft, 30" L 4430
36" with 4" and 6" disks,
150/Skid

0120023 36" w/ 4" and 6" disks

Not stocked at all locations



Cross Drive Anchors

Drive anchor with fastening and tensioning head, 3/4" shafts. Welded tubing guides the two 48" long drive rods. Designed to be driven into solid rock. 200/Skid; 4/Box.

Recommended for
Soil Class 1/Solid Rock

0120002 48" Long

0120010 36" Long

0120017 Head Only

0120048 36" Rod Only



ZipCap



0120028 HP34 ZIPCAP only, 8/Bdl.

Minute Man anchors,™

GW-2 Anchor

Nu Concept Anchor includes:

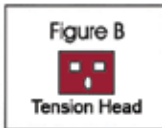
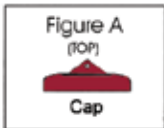

0120022 GW-2 Soil Anchor

0121022 GW-2 Soil Anchor, Galvanized

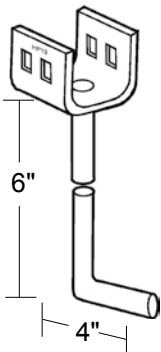

Patio Slab Anchors

Patio slab hooked rod attachment with fastening and tensioning head installed when pouring concrete slab. 16/Box



- 0120007** "L" Anchor
- 0121007** "L" Anchor, Galvanized
- 0120005** "J" Anchor w/Swivel Head
- 0121005** "J" Anchor w/Swivel Head, Galv.

Anchor Head With Sleeve

Use with wet concrete.

0120334
 1-Pc. Unit
 (Head w/Bolt
 and Sleeve)

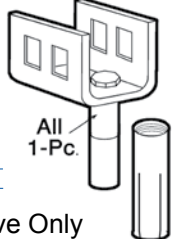

0120015 Sleeve Only

Solid Eye Adaptor

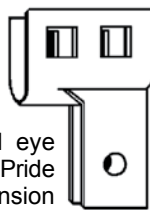

Adaptor for solid eye anchor with Home Pride fastening and tension head.

0120209 24/Ctn.

Anchor Head With Lag Bolt



0120009 2-Pc. Unit; 32/Box
0121009 Galvanized; 32/Box

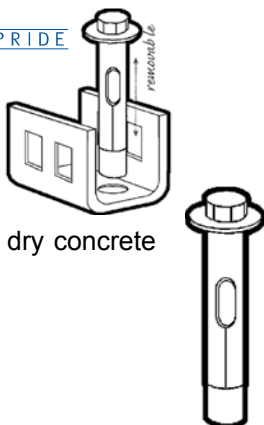

Double tensioning device for use on dry concrete or existing concrete slabs. 48/Ctn.

0120014 Head Only
0121014 Head Only - Galvanized
0120018 5/8" Lag Bolt Only

Anchor Bolt & Nut



Knurled bolt increases friction between strap and bolt shaft for greater strength than smooth bolts. Slotted for use with strap. Not included with anchor.



0120006 400/Keg, 8/bag

B-2

M-Plate Stabilizer



- More cutting points for better balance
- Smaller and shorter plate is easier to get into ground.
- "Power Ridge" provides extra strength for as much or more resistance than traditional plates
- More resistance concentrated at the top of the anchor, so plate performs as good or better than traditional plates even though it is smaller
- Meets all state requirements except FL, so can replace traditional stabilizer plates
- Average installation in 1/3 the time of traditional plates

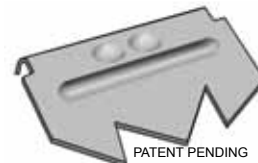

PATENT PENDING

0120188 7"H x 12"W M-Plate, 8/Box

0121188 7"H x 12"W M-Plate 8/Box, Galvanized

Anchor Stabilizing Device



Prevents anchors from becoming loose by cutting through the soil when heavy winds occur.
 Required in most anchor installations.

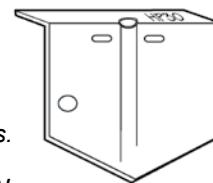

0120180 Stabilizer 12"H x 12"W

0121180 Stabilizer 12"H x 12"W, Galvanized

Stabilizer Plate



ABS Lateral Stabilizer Plate, Designed for loose soil conditions. 10" x 24" Class 4B Fla.; 6/Bdl.

0120186

Stabilizer Plate

Wind Zones 2 & 3



ABS Stabilizer Plate 1055-19

0120181

Speed Wrench

No more scraped up hands!

One handed operation tightens bolt & strap at the same time. 15/16" impact socket on one side and a 15/16" nut on the other. Combine with your own ratchet and 15/16" socket, and you have the fastest way to tighten slotted bolts.

0380107



Double Buckle w/8' Strap

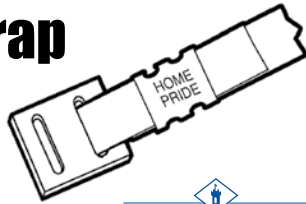

0120296 Box
0120297 Bulk



Single Buckle with Strap

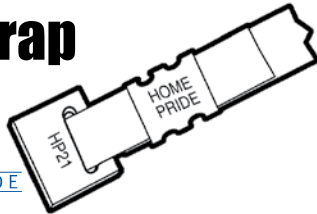

Galvanized strap with single buckle for fastening around home frame. 4/Bdl.

- 0120290 w/7' L Strap; Boxed; 48/Ctn.
- 0120308 w/7' L Strap; Bulk
- 0120275 w/8' L Strap; Boxed; 48/Ctn.
- 0120295 w/8' L Strap; Bulk
- 0120291 w/10' L Strap; Boxed; 32/Ctn.
- 0120292 w/10' L Strap; Bulk
- 0120294 w/15' L Strap; Bulk

Strap Buckle

Steel strap buckle for use in fastening strap around frame of mobile home.



- 0120311 2-Slot Buckle; 200/Bx
- 0120314 2-Slot Buckle; Each
- 0120300 1-Slot Buckle; Each

Strap Protector

Attaches between strap and I-beam to prevent cutting or breaking.

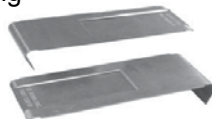

0120283

Strap Seal Crimping Tool

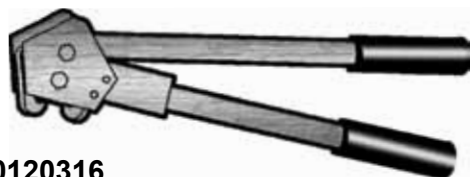

0120316

7' Column Tie-Down



For marriage wall columns where opening is 48" or larger. Fasten to the column above the normal up-lift straps or to block with 13#8 1-1/4" screws (minimum).

0120435 HP38

Frame Clamp II with Strap

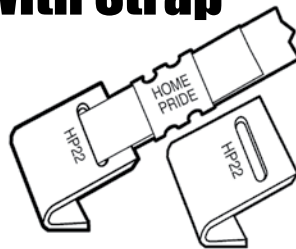

Frame clamp with strap for fastening around bottom flange of home frame. 4/Bdl.

- 0120313 Clamp II Only; 24/Ctn.
- 0120324 w/6' L Strap; Bulk
- 0120325 w/7' L Strap; 48/Box
- 0120329 w/7' L Strap; Bulk
- 0120330 w/8' L Strap; Bulk
- 0120276 w/8' L Strap; 48/Box
- 0120326 w/10' L Strap; 32/Box
- 0120348 w/10' L Strap; Bulk
- 0120312 w/12' L Strap; Bulk
- 0120331 w/12' L Strap; 32/Box
- 0120327 w/15' L Strap; 32/Box
- 0120328 w/15' L Strap; Bulk

Strap with Quick Connector



- 0120380 6' Strap with Small Connector Hole
- 0120384 7' Strap with Large Connector Hole
- 0120383 5' G120 Strap with Large Connector Hole (F1 Approved)

Anchor Strap



1-1/4" wide (with standard galvanized coating) strapping exceeds 4,725 lbs. breaking strength. (100 lb. roll: approx. 650'.)

- 0120301 37' L Roll, G-60; 12/Ctn.
- 0120307 100 lb. Roll, G-60

Same as above but with galvanized coating, approved for Florida.

- 0120431 37' L Roll, G120; 12/Ctn.
- 0120430 100 lb. Roll, G120

Strap Seal

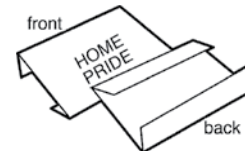

Secures strapping together with buckles or frame clamps. Must use strap seal crimping tool (120316). 300/Ctn.

0120299



Strap Connector

Universal Swivel/
Sidewall Connector
w/G120 Strap



- 0120417 Galvanized Strap; 6'
- 0120482 Galvanized Strap; 8'

Roof Bracket

Use for cable or strap passing over the mobile home. Holds straps or cable away from roof and sides. 100/Ctn. (Black steel, not galvanized.)



0120302 6", 24/Box

0120304 L-Bracket for Hurricane StraP

Beam Hooks

Use with swivel frame connectors for attaching anchor straps to I-beams.



0120406 3", 24/Box

0120407 4", 24/Box

0120408 Double, 24/Box

Not stocked at all locations

Swivel Connector with Strap

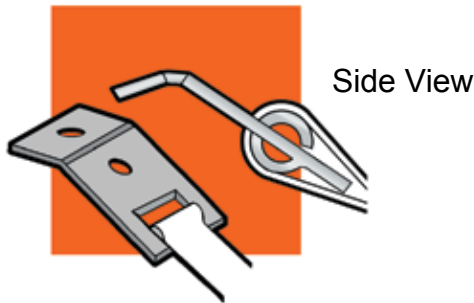

Factory attached strap for applications where use of standard frame ties is prohibited. To be used with beam hook. 4 per box. (Not stocked at all locations)

0120415 5' L Strap with Swivel Connector, 400/Skid

0120481 6' L Strap with Swivel Connector, 400/Skid

0120404 7' L Strap with Swivel Connector, 400/Skid

0120405 10' L Strap with Swivel Connector, 400/Skid

0120416 12' L Strap with Swivel Connector, 200/Skid

Longitudinal Frame Tie (4 Bolt)

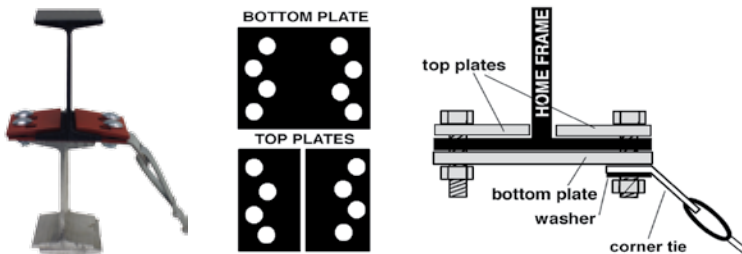

Use outside holes for 3-1/2" to 4" flanges; use inside holes for 2" to 3" flanges. For Wind Zone 1. 4 1/2" x 1-1/2" Grade 5 machine bolts and 8 1/2" high strength washers included.

0120420 MMA34/2822

Minute Man anchors, Inc.

Corner Tie With 7' Strap

0120421 2709, 400/Skid

Minute Man anchors, Inc.

Angle Bracket

Use with swivel frame connectors for attaching anchor straps to I-beams.

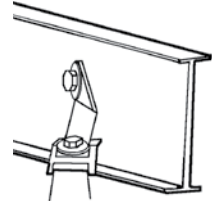

0120409 HP24, 24/Box

0120418 Replacement Nut and Bolt, 50/Box

Not stocked at all locations

Gator Clamp

(Longitudinal Beam Clamp)

Use with swivel frame connectors for attaching anchor straps to I-beams.

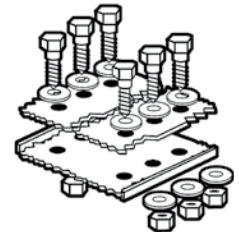

0120410 HP28, 4/Pk

Not stocked at all locations

Stable Safe Tie Downs

- Anchors solidly against wind to concrete foundations
- Eliminates motion caused by wind or occupant movement
- No hurricane straps are required
- Takes only minutes to install
- Adjusts in seconds to the exact height
- Requires no maintenance
- Install when concrete is being poured
- 16/Box



0120333

Vinyl Coated, Galvanized Cable

Heavy duty, ABS Molded Plastic Cable;
Size: 1/8 x 3/16"; Const.: 7x7
B.S. lbs.: 1700;
S.W.L. Lbs.: 340
Wt.: 20.1; Spool: 6"

0120470 500' L



Electric Anchor Machine



Features 12 RPM, 1/2 HP, 115 volt, 6 cycle, 9 amp motor, on-off, forward-reverse switches. With its 12 RPMs, it far outpaces any 6- or 9-RPM units. When running off a generator, a minimum of 4500 watts is required.

- 0120315** Reversing Switch
- 0120317** Anchor Adapter Only
- 0120318** On-Off Replacement Switch
- 0120319** Electric Anchor Machine Only



0120120
Eye Anchor Adapter



0120317
Anchor Adapter Only

Anchors may be effectively and safely installed manually, but the electric auger machine will make the job easier and faster. Remember, however, that this method of installation requires two people.

Always make sure to avoid underground water, phone and power lines.

Attach the anchor to drive machine. Line up the auger with the strap and start machine. Install anchor at a slight angle (12° - 15°) underneath the house. This will ensure that the head of the anchor will be concealed behind future skirting.

RIDGID 700 Portable Power Drive



Heavy-duty hand-held power drive. Features reversible 115V or 230V universal motor. Horsepower: 1/2; RPM: 32; Weight: 25 lbs.; 115 AC. All shafts are ball-bearing mounted. Gears are packed in grease. Spring-loaded adapted pawls with forged steel spindle gear. No load: 7.5 amps, 750 watts With load: 18.0 amps, 1750 watts. Includes: drive, metal carrying case, attachment handle, connector, square adaptor. CSA approved. Approved to UL standards (NRTL).



- 0120260** Ridgid 700 Drive Installer Package
- 0120261** 1" Adaptor

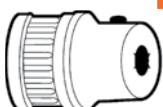

- 0120264** Replacement Brushes
- 0120263** Square Adapter Assy. (HP71)

Specifications Subject to Change without Notice



Hydraulic Earth Drill



- **Portable:** for one person operation and easy maneuverability
- **Torque Free:** for maximum operator safety and no kick back
- **Hydraulic:** Powerful 11 HP Honda power source is reliable and reversible
- **Versatile:** Fencing, foundations, soil sampling, anchor installation & more



Little Beaver's Hydraulic Earth Drill has a highly maneuverable three-wheel chassis with pneumatic tires, a five-gallon hydraulic reservoir and an 11 HP engine. Patented torque tube eliminates the kickback found on other earth drills, so one-man drilling is safe, fast and productive.

- 0120710** Complete Assembly includes:
Little Beaver 11 HP Power Source
Anchor Handle Attachment
Anchor Adaptor
- 0120700** Power Source
- 0120701** Handle Attachment
- 0120702** Replacement Adaptor

Outdoor Improvements

Anchors & Set-Up Material

Doors & Windows

Coatings & Cleaners

Appliances

Tools & Hardware

Carpet & Flooring

Electrical

Plumbing

Towing & Safety

Heating & Cooling

Portable Building Anchors

HOME PRIDE

For use ONLY on portable buildings and sheds. 5/8" Rods

- 0120305** 30" Long
4" Single Disc
- 0120303** 30" Long
4" Double Disc
- 0120304** 30" Long
4" Double Disc
w/out Plate
- 0120309** 20" Long
w/ 2" & 4" Discs

Not stocked at all locations

0120305

0120303

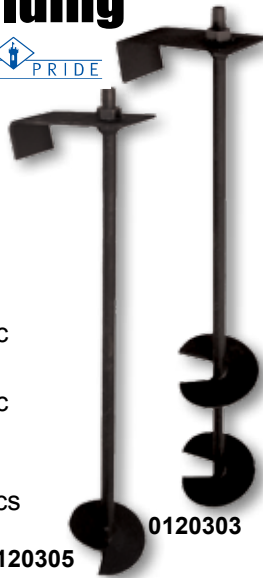

Barbed Anchors

HOME PRIDE



0120026*

0120033

0120039

* Note: Head on 0120026 not welded to shaft of anchor

- 0120026*** 24" for Rock, 3/4" Shaft, 200/Skid
- 0121026** Same as 0120026, but Galvanized
- 0120024** 26" with Cable & Lag, 5/8" Shaft
- 0120032** 34" for Coral with Head, 3/4" Shaft
- 0120033** 30" for Asphalt, 3/4" Shaft, HP9-A, 200/Skid
- 0120034** 30" for Asphalt with Bolt Hole, 3/4" Shaft, 2 Hole Bracket
- 0120039** 24" U-Shaped Barb Anchor

Not stocked at all locations

Shed Anchor Kit

Minute Man anchors, Inc.

Four Eye Anchors
15" Long,
w/ 3" Disk and 50' of
500 lb. test cable.

0120306 Shed Anchor Kit

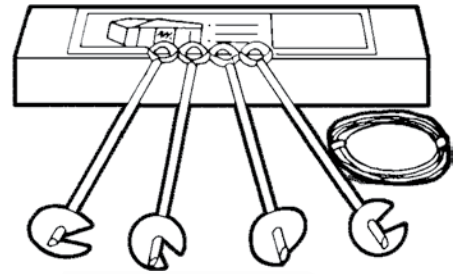

Shed Anchor Kit

A necessity for wind protection with thousands of uses.

Each kit contains:

- 4 30" eye anchors with 4" helix
- 4 1/8" galvanized clamps
- 60' 1/8" galvanized aircraft cable



0120298 Shed Anchor Kit

0120480 Eye Anchor Only

Eye Anchor

HOME PRIDE

Shaft: 5/8" Eye: 1-1/2"

- 0120101** 48" L; 6" Single Disc
- 0120102** 30" L; 4" Single Disc
- 0120115** 30" L; 4" Disc
- 0120021** 30" L; Double 4" Discs
- 0120044** Length: 5/8" x 36"
- 0120035** Bolt Set – includes:
2" Fender Washers, 1/2" Nut,
4-1/2" x 1/2" Hex Hd Bolt
- 0120120** Eye Anchor Adapter



AC Pad Anchor System

Easy to install. No cables. No special tools. Great theft deterrent. Two anchors plus Tek screws included with system.

0120040 AC Pad Anchor System

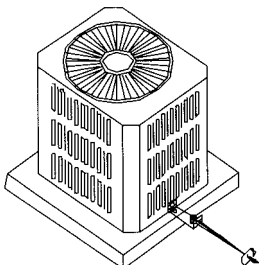

PolyVulc

Soil Test Probe Kit



Determines soil conditions below the surface near the anchor's helical plate. Provides maximum anchor holding strength by insuring the use of the proper anchor for each soil condition. Complete with carrying case, torque wrench, wrench adapter and instructions.

0120321

Minute Man anchors, Inc.

Pocket Penetrometer

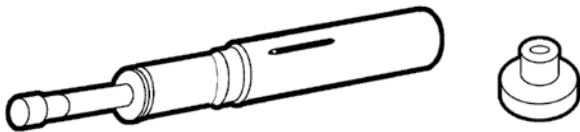

Direct-reading scale in tons/square feet. Ground and polished stainless-steel loading piston. Calibrated spring and penetrometer body plated for rust-resistance and long life. Complete with convenient belt-loop carrying case.

0120322 Penetrometer
0120323 Foot



PolyVulc The Black Pad® Pier Pad



Lightweight, heavy-duty recycled materials, superior drainage. Reduces Worker's Comp. claims. New design is **stronger** than ever with more surface area to distribute weight evenly for greater pier spacing so you need fewer pads! Answer to **new regulations** calling for larger footprint pad for heavier homes.

Cost efficient: costs LESS and is stronger than stacking THREE of the competitor's pads to handle the same weight. 100% recycled composite materials.



- 0265440 16" x 16" x 1"; 15/Bundle; 405/Skid
- 0265444 17" x 23" x 1"; 15/Bundle; 240/Skid
- 0265431 18.5" x 18.5" x 1"; 15/Bundle; 270/Skid
- 0265432 20" x 20" x 1"; 15/Bundle; 270/Skid
- 0265448 24" x 24" x 1"; 15/Bundle; 160/Skid

Specifications Subject to Change without Notice

ABS Oval Foundation Pads

For use on mobile, manufactured homes, and modular housing. Patent #5503500 and other Patents Pending

Benefits: Easy Installation, Cost Efficient, Thicker, Lighter, and Stronger, Maximize Time and Areas of Labor, Saves On Shipping and Handling, Made from Recycled Materials



17" x 22" Oval Pad Shown

Item #	Oval Pad Size	Max. Load Capacity (lbs.)
0265205	16" x 18.5"	6,000
0265206	17" x 22"	7,500
Special Order	17.5" x 22.5" (Oklahoma Pad)	8,000*
0265208	17.5" x 25.5"	9,000*
0265209	21" x 29"	12,000*
0265210	23.25" x 31.25"	9,388*

* Concrete blocks are only rated at 8,000 pounds. 8,000 lbs and higher must be double blocked.

ABS Square Foundation Pads

For use on all mobile and manufactured homes, including HUD approved homes and modular housing. Patent #5503500 and other Patents Pending

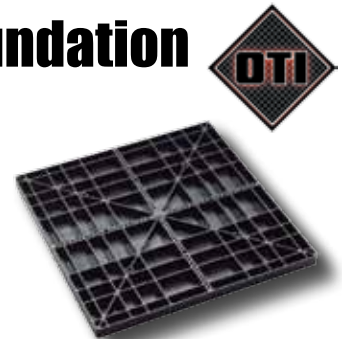

Benefits: Same As Above
24" x 24" Square Pad Shown

Item #	Square Pad Size	Max. Load Capacity (lbs.)
0265200	16" x 16"	5,333
Special Order	13" x 26"	2,375
0265202	18.5" x 18.5"	7,100
0265203	20" x 20"	8,250*
0265204	24" x 24"	8,000*

* Concrete blocks are only rated at 8,000 pounds. 8,000 pounds and higher must be double blocked.

ABS Foundation Pad®

- Bigger, thicker, stronger and better
- Lighter than concrete, saves labor
- Larger pads to increase spacing, by up to 12% saving time and material on pier sets
- Easily stackable for larger pad area and wider pier spacing
- Triple stack for 4, 5 & 6 Sq. Ft. to maximize pier spacing

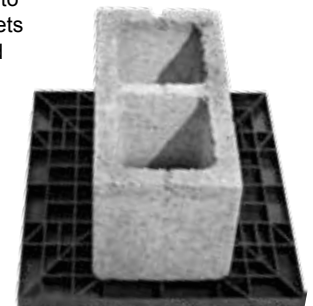

- 0265445 16" x 22.5" x 2.5 sq ft
- 0265446 17" x 25" x 3 sq ft
- 0265447 16" x 18" x 2 sq ft
- 0265448 24" x 24" x 4 sq ft

Outdoor Improvements

Anchors & Set-Up Material

Doors & Windows

Coatings & Cleaners

Appliances

Tools & Hardware

Carpet & Flooring

Electrical

Plumbing

Towing & Safety

Heating & Cooling

Minute Man anchors, Inc.

Longitudinal & Lateral Stabilizing Systems

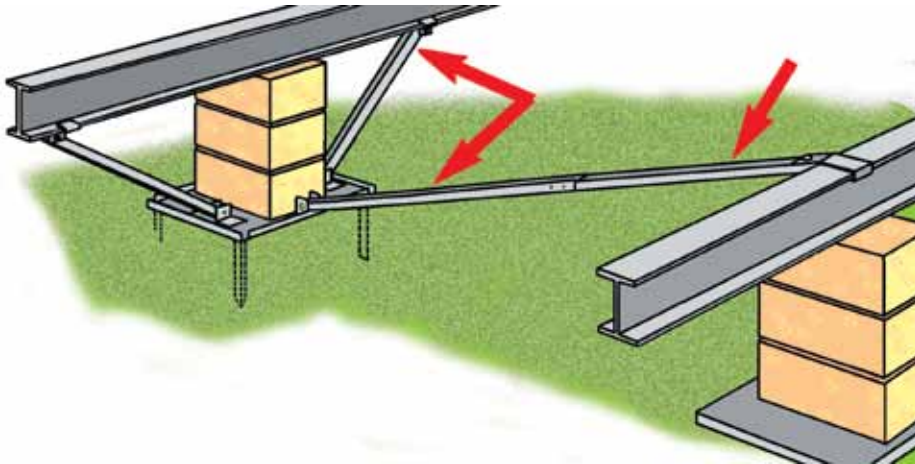

Top-quality heavy gauge steel throughout system

Versatile: provides combined lateral and longitudinal support, or only lateral, or only longitudinal

Flat pad design installs easily, eliminates digging and driving foundation pad into ground

Exceeds requirements for all wind zones. Eliminates frame ties and stabilizers, saving time and money.

- Versatile: provides combined lateral and longitudinal support, or only lateral, or only longitudinal
- Flat pad design installs easily, eliminates digging and driving foundation pad into ground
- Top quality, heavy gauge steel provides stability
- Utilizes adjustable tubing for structural integrity with less inventory
- Easy to install and neatly packaged for warehousing and transport

Lateral Longitudinal Lateral/Longitudinal

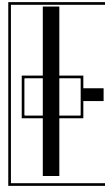
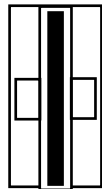
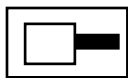

Minute Man anchors, Inc.

Longitudinal System Includes:

- 1 - 20" Galvanized Steel Pad
- 2 - Beam Clips with Hardware
- 2 - 1.5" Square Bracing Tubes

- 0120355** 39" Longitudinal System for All Zones
- 0120356** 44" Longitudinal System for All Zones
- 0120357** 53" Longitudinal System for All Zones

Lateral/Longitudinal System Includes:

- 1 - 20" Galvanized Steel Pad
- 1 - 60" Adjustable Lateral Tube with Hardware
- 2 - Beam Clips With Hardware
- 2 - 1.5" Square Bracing Tubes

- 0120377** 39" Lateral/Longitudinal System for All Zones
- 0120378** 44" Lateral/Longitudinal System for All Zones
- 0120379** 53" Lateral/Longitudinal System for All Zones

* Refers to the length of the bracing tube

Lateral System Includes:

- 1 - 20" Galvanized Steel Pad
- 1 - 60" Adjustable Lateral Tube with Hardware

- 0120370** Lateral System
Not stocked at all locations

Replacement Pins for Pan Systems

- 0120368** 16" Pin

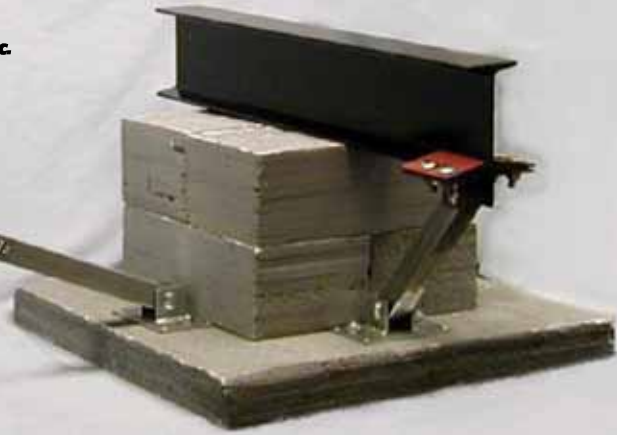

Concrete Dry Set Longitudinal System

includes:

- 2 - 0120346 Dry Set Flanges and Hardware
- 2 - 0120350 Beam Clips With Hardware
- 2 - 1.5" Square Bracing Tubes

0120385 39" Dry Set Longitudinal System

0120386 44" Dry Set Longitudinal System

0120387 53" Dry Set Longitudinal System

Wet Set Longitudinal System

includes:

- 2 - 0120347 Wet Set Flanges and Hardware
- 2 - 0120350 Beam Clips With Hardware
- 2 - 1.5" Square Bracing Tubes

0120388 39" Wet Set Longitudinal System

0120389 44" Wet Set Longitudinal System

0120390 53" Wet Set Longitudinal System

60" Lateral Dry Set System

includes:

- 1 - 0120346 Dry Set Flange and Hardware
- 1 - 0120349 60" Lateral Tube and Hardware

0120395 Lateral Dry Set System Assy.

0120340 Lateral Dry Set System Assy. (for Missouri)

60" Lateral Wet Set System

includes:

- 1 - 0120347 Wet Set Flange and Hardware
- 1 - 0120349 60" Lateral Tube and Hardware

0120396 Lateral Wet Set System Assy.

Guide to Components for Longitudinal & Lateral Stabilizing Systems

These are the components of the assemblies on these two pages. You do NOT need to order them separately, but the following part numbers and descriptions are provided for your information.



0120350
Beam Clip (bottom of beam) with Bolts & Nuts

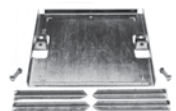

20" Galvanized Steel Pier Pad
0120358 w/16" Drive Pins
0120368 16" Pins

0120320 Replacement Hardware Pack

Hardware Pack Contains:

- (2) 2" x 7-3/4" Lateral Clamps (top of beam)
- (2) 1-5/8" x 2" Tube Clamps
- (4) 1/2" x 2-1/2" Bolts & Nuts
- (2) Instruction Sheets

- (2) 1/2" x 1-1/2" Bolts & Nuts
- (2) 1/2" x 1-3/8" Washers
- (8) 1/4" x 3/4" Self Drilling Screws

0120346 3534 Mark MMCAF Dry Set:

- 1 - Concrete Anchor Flange: MMCAF
- 1 - 1/2" x 1-1/2" Carriage Bolt and Nut
- 2 - 5/8" x 3" Shield Anchors

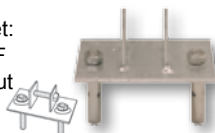

0120347 3536 Mark MMCFW Wet Set:

- 1 - Concrete Anchor Flange: MMCFW
- 1 - 1/2" x 1-1/2" Carriage Bolt and Nut

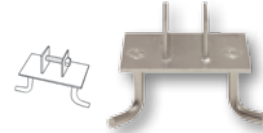

0120349 60" Adjustable Lateral Tube With Hardware (3530)

0120352 39" L. Square Bracing Tube

0120353 44" L. Square. Bracing Tube

0120354 53" L. Square Bracing Tube

0120359 65" x 1.5" Square Bracing Tube (Optional)



VECTOR SYSTEM LATERAL STABILIZATION FOR CONCRETE

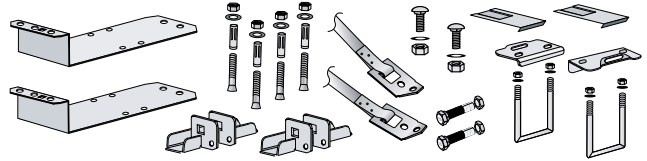
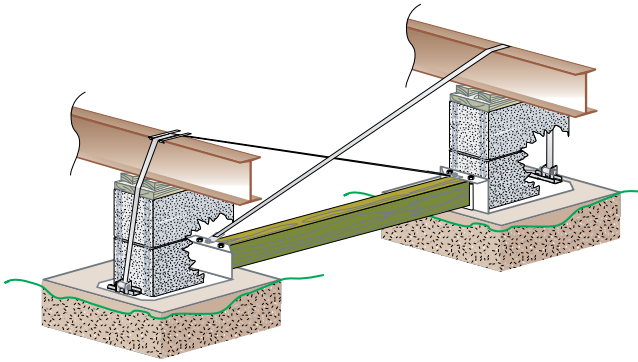

0120441 - Single block pads with hardware, swivel straps and slotted bolts.

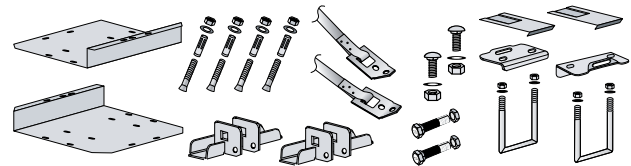
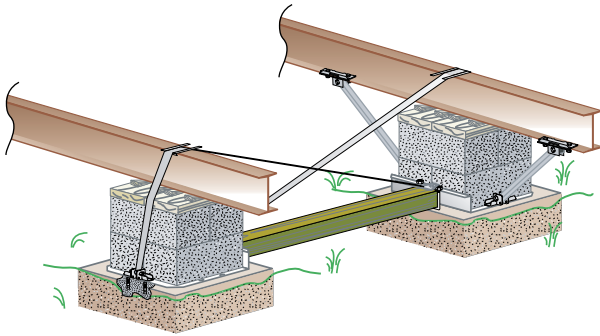

0120440 - Double block pads with hardware, swivel straps and slotted bolts.

Longitudinal Stabilization Hardware Kit for Concrete

0120477 - Includes 2 beam clamps, tension brackets, nuts and bolts.

For use with 0120440 & 0120441, (longitudinal struts not included)

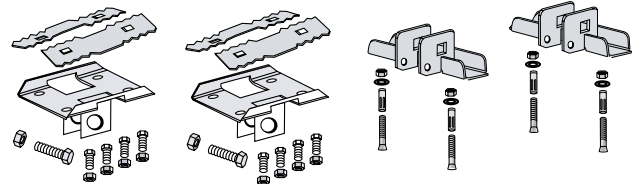

Struts for Longitudinal Systems

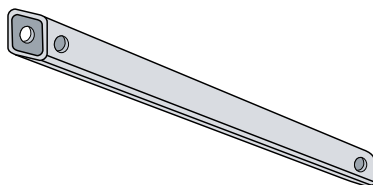

STRUTS FOR LONGITUDINAL SYSTEMS		
PART NO.	LENGTH	PIER HEIGHT
0120473	30"	up to 2 Blocks
0120445	39"	up to 3 Blocks
0120446	44"	up to 4 Blocks
0120447	53"	up to 5 Blocks
0120448	65"	up to 6 Blocks



Foundation Systems Component Parts List

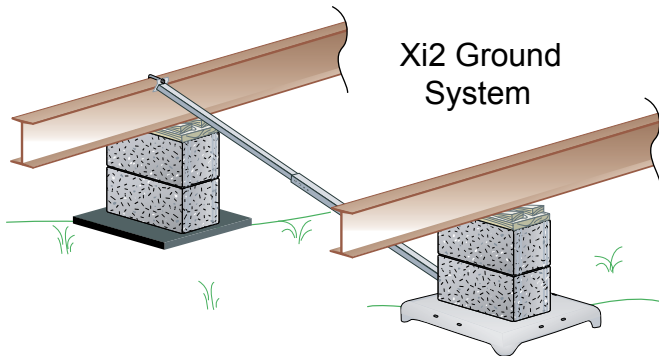

Xi2 Ground System

Xi2 Ground Systems

Includes:
5' Strut
Pad
Hardware

0120487

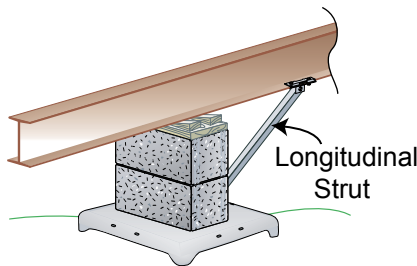

Longitudinal Strut

Longitudinal Struts for "Ground Systems"

Part No.	Length	Pier Height
059330-30	30"	up to 2 Blocks
059330-39	39"	up to 3 Blocks
059330-44	44"	up to 4 Blocks
059330-53	53"	up to 5 Blocks
059330-65	65"	up to 6 Blocks

Special Order Only

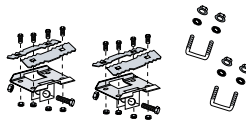

Ground Longitudinal Hardware Kit

Longitudinal Hardware Kit

0120489 (Includes 2 sets per kit: I-beam brackets, U-bolt, nuts, bolts and washers)

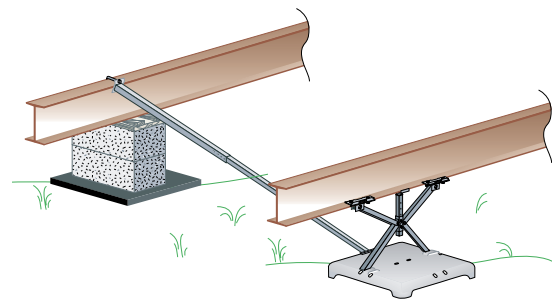

Xi System with Xi Steel Pier

- 0120498 - Xi, 12" steel Pier, & Longitudinal System
- 0120490 - Xi, 25.5" steel Pier, & Longitudinal System
- 0120494 - Xi, 36" steel Pier, & Longitudinal System

Steel Piers can be combined with one of the following for lateral support:

- 0120491 - Xi, Lateral Strut, 5' w/hardware
- 0120496 - Xi, Lateral Strut, 5' w/hardware - GA
- 0120495 - Xi, Lateral Strut, 6' w/hardware
- 0120497 - Xi, Lateral Strut, 6' w/hardware - GA
- 0120488 - Xi Steel Pier Hardware Kit

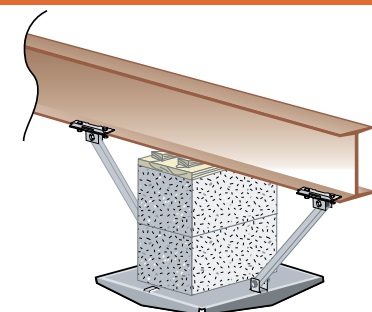

3 Sq. Ft. Pad Vector Longitudinal System

Includes 2 beam clamps, 2 tension brackets, nuts & bolts.

Struts for Longitudinal System on Page B-10

- 0120442 - 3' Vector Pad
- 0120478 - Longitudinal Hardware



All Steel Foundation Systems

Versions of the ASF Systems are available for every wind zone

Systems can be purchased to offer lateral protection, or lateral & longitudinal protection

Systems are available for pre-poured concrete sets, and pre-existing concrete sets

Cost Efficient

Longitudinal system eliminates 2 piers

Approved for use with most home manufacturers

Eliminates Most Frame Anchors

Eliminates 2 Piers

Lateral System



Wind Zone 1

- ◆ 0120525 1100 ITV Lateral Pan System
- ◆ 0120526 1100 ITCV Wet Concrete Lateral Pan System
- ◆ 0120527 1100 ITCV Dry Concrete Lateral Pan System

Lateral & Longitudinal System



For Complete System Add Appropriate Conversion Kit & Tube To Above Lateral System

Wind Zone 1 & 2

- ◆ 0120460 Longitudinal Pan Conversion Kit
- ◆ 0120462 Longitudinal Wet Concrete Conversion Kit
- ◆ 0120461 Longitudinal Dry Concrete Conversion Kit

Longitudinal Tubes (2 req.)			Longitudinal Tubes (2 req.)		
Zone 1 & 2	Size	Pier Height	Zone 1 & 2	Size	Pier Height
0120582	20"	14" - 18"	0120585	44"	30" - 40"
0120583	28"	18" - 25"	0120586	54"	36" - 48"
0120584	39"	24" - 35"			

North Carolina Lateral System



Wind Zone 1

- ◆ 0120530 NC-1100 ITV Lateral Pan System
- ◆ 0120531 NC-1100 ITCV Wet Concrete Set
- ◆ 0120532 NC-1100 ITCV Dry Concrete Set

Wind Zone 1 & 2

For Complete System Add Appropriate Conversion Kit & Tube To Above Lateral System

- ◆ 0120460 Longitudinal Pan Conversion Kit
- ◆ 0120464 Wet Set Concrete Conversion Kit
- ◆ 0120463 Dry Set Concrete Conversion Kit

N. Carolina Long. Tubes (2 req.)			N. Carolina Long. Tubes (2 req.)		
Zone 1 & 2	Size	Pier Height	Zone 1 & 2	Size	Pier Height
0120587	20"	14" - 18"	0120590	44"	30" - 40"
0120588	28"	18" - 25"	0120591	54"	36" - 48"
0120589	39"	24" - 35"			

ASF Florida System



- ◆ 0120533 Lat./Long. Pan System - Less Longitudinal Tubes
- ◆ 0120537 Lat./Long. Wet Concrete System - Less Long. Tubes
- ◆ 0120538 Lat./Long. Dry Concrete System - Less Long. Tubes
- ◆ 0120534 Long. Pan System - Less Longitudinal Tubes
- ◆ 0120535 Long. Wet Concrete System - Less Tubes
- ◆ 0120536 Long. Dry Concrete System - Less Tubes

Florida Long. Tubes (2 req.)			Florida Long. Tubes (2 req.)		
Zone 1 & 2	Size	Pier Height	Zone 1 & 2	Size	Pier Height
0120575	14"	12" - 18"	0120578	44"	33" - 41"
0120576	22"	17 ³ / ₄ " - 25"	0120579	54"	40" - 48"
0120577	32"	24 ³ / ₄ " - 33"			

ASF Michigan System



- ◆ 0120592 Dry Concrete Hardware Kit
- ◆ 0120580 5' Lateral Arm

ASF Georgia System



- ◆ 0120539 Lateral Pan System

All Steel Foundation System Replacement Parts



All Steel Foundation Systems

Part #	Parts Description	Pallet Qty.
0120366	Bolt Bag for Longitudinal System	Bag Each
0120367	Extended I-Beam Clamp (1100-9xP)	
0120582	20" Longitudinal Arm (Painted)	4/Bndl. Each
0120583	28" Longitudinal Arm (Painted)	4/Bndl. Each
0120584	39" Longitudinal Arm (Painted)	4/Bndl. Each
0120585	44" Longitudinal Arm (Painted)	4/Bndl. Each
0120586	54" Longitudinal Arm (Painted)	4/Bndl. Each
0120625	5' Lateral Arm (Painted)	2/Bndl. Each
0120632	20" Longitudinal Arm (Galvanized)	4/Bndl. Each
0120633	28" Longitudinal Arm (Galvanized)	4/Bndl. Each
0120634	39" Longitudinal Arm (Galvanized)	4/Bndl. Each
0120635	44" Longitudinal Arm (Galvanized)	4/Bndl. Each
0120636	54" Longitudinal Arm (Galvanized)	4/Bndl. Each
0120626	5' Lateral (Galvanized)	
Part #	Florida Replacement Parts	
0120637	18" x 1.5" Telescoping Arm	
	To be used with one of the following arms	
	Part #	Longitudinal Tubes
	0120638	14" x 1.25" Longitudinal Tube
	0120639	22" x 1.25" Longitudinal Tube
	0120640	32" x 1.25" Longitudinal Tube
	0120641	44" x 1.25" Longitudinal Tube
	0120642	54" x 1.25" Longitudinal Tube

Adjustable Outrigger



- ◆ Costs less than perimeter blocking under doors and windows
- ◆ Unaffected by frost heave
- ◆ Eliminates problems with anchor spacing
- ◆ Easy to install
- ◆ Never interferes with skirting
- ◆ Doors easily adjusted
- ◆ Never settles
- ◆ Tested and approved
- ◆ D.A.P.I.A. approved

0120280 14" Wide
0120281 16" Wide

Hydraulic Jacks

Bottle Jacks



Fifty-percent safety overload factor. Fewer parts, internally machined oil passages, smooth bearing surfaces and close tolerances ensure longer life and fewer breakdowns. No-leak "Uni-weld" construction. Can be used in vertical, angular or horizontal positions. Carrying handle included.



- 0410191** 12 Ton Standard; 4/Ctn.
0410190 12 Ton Shorty; 4/Ctn.
0410192 20 Ton; 2/Ctn.
0410196 Repair Kit for 20 Ton 76520, 76820 (2-9/16" plunger)
0410189 Repair Kit for 12 Ton (2-9/16" plunger)
0410193 Oil Filler Plug; 25/Ctn.

Air Hydraulic Jacks



Equipped with U.S. Patented air motor kit for quick, easy lifting. Quick-connector provides easy removal of air hose. Uses standard shop air. Min. 9-1/2" H, max. 18-5/8".

- 0410050** 12 Ton; 26 lbs.
0410051 20 Ton; 35.2 lbs.



Adjustable Perimeter Support

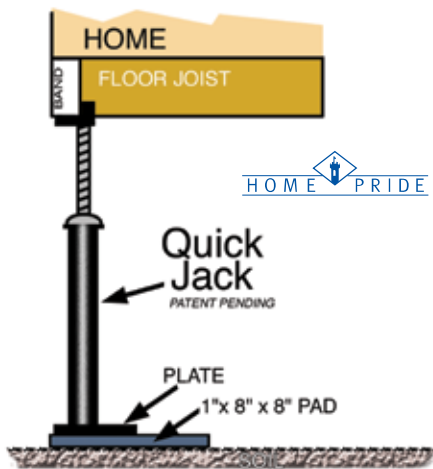

FEATURES	BENEFITS
Adjustable from 28" to 40" with threaded rod design	Set up of perimeter piers takes only minutes. SAVES TIME!
Added base blocks allow additional height	Versatile: can be used in a variety of set-up situations
Adjustable system with nut is easy to use	Homeowner can make adjustments on their own, so fewer call backs and lower service costs!
Light, compact design	Easier to transport and handle than concrete blocks
Strong: capacity of up to 4,000 lbs.	Provides all the support needed for doorways and bay windows

For use in supporting doorways and windows for manufactured housing and portable buildings.

0120285 HP62; 4/Box

Jacking Plates

Use when jacking the frame's main beam to avoid damage to the beam and voiding of the warranty. Distributes the concentrated load of the jack head to the frame members. Prevents home from slipping off the jack and causing injury.

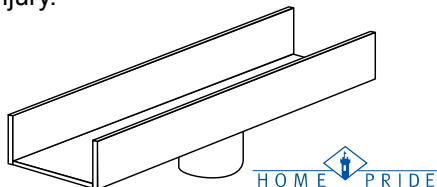

0120250

B-14

Frame Pullers

Attach the puller to the I-Beams at the top of the frame. To be used with come-along.



0120255 Frame Pullers

Heavy Duty Utility Rollers

These heavy duty utility rollers are a low cost alternative to other more complete systems. They have a strong steel back plate, which allows you to crib directly on top of the roller. The steel back plate can be removed. They can be rolled on most smooth hard surfaces.



0411465 Flat Top Utility Roller, 5 Ton Capacity

0411466 Point Jack Utility Roller, 5 Ton Capacity

For additional weight capacity order sets as follows.

SETS	CAPACITY	PARTS & QUANTITY TO ORDER
3 point set	27,000 lbs	2 - Flat Top + 1- Point Jack Roller
4 point set	36,000 lbs	4 - Flat Top
5 point set	45,000 lbs	4 - Flat Top + 1- Point Jack Roller

4 Point Multi-Directional System



40,000 LB CAPACITY

System includes:

- 4 - 5' Aluminum Rolling Channel
- 4 - 6 Roll High Capacity Lower Dolly
- 4 - Hydraulic Jack Dolly Guide, 15"
- 4 - Jack Head Plate
- 4 - 6 Roll High Capacity Upper Dolly

12 Ton Jacks sold separately (see page B-14). This system is not recommended for homes over 70' long

Warning:

As a safety precaution, tires and axles should be left on the home as long as possible and/or proper safety cribbing used with this equipment.

0411470

Extra Heavy Duty Cable Puller

Capacity:
3 ton

Weight: 23.9 lbs

Includes 18' of flexible 5/16" wire cable. Portable to go anywhere. 3:1 safety factor.

0382008



Ratchet Puller

Leverage: 36:1

Capacity: 2 tons; 2:1 safety factor
1 ton; 4:1 safety factor

Lift: 6'

Galvanized 3/16" aircraft cable, plated steel frame & parts. Each unit tested before shipment. Weight: 7.2 lbs.

0382009



Minute Man anchors, inc. Home Piers

Lightweight and stackable for easy storage, shipping and handling. Adjustable heights for precise installation. Only 16 piers replace the 64 concrete blocks normally required to support a 70' x 14' mobile home. Withstands in excess of 15,000 lbs. of pressure—more than 12 times the actual mobile home load of 1,268 lbs. on each stand. Ideal for quick, secure setups in dealer lots as well as the home site.

PIER HEAD NUT MUST BE ORDERED WITH EACH PIER

Painted Piers

- 0120196** 12"
- 0120202** 14"
- 0120197** 16"
- 0120198** 18"
- 0120203** 20"
- 0120199** 22"
- 0120200** 24"
- 0120204** 26"
- 0120205** 28"
- 0120206** 30"
- 0120192** Pier Head w/Nut

Galvanized Piers

- 0121196** 12"
- 0121202** 14"
- 0121197** 16"
- 0121198** 18"
- 0121203** 20"
- 0121199** 22"
- 0121200** 24"
- 0121204** 26"
- 0121205** 28"
- 0121206** 30"
- 0121192** Pier Head w/Nut

Roof Jacks

Made exclusively for the Manufactured Housing Industry

For jacking from the ground:

The fast, simple, inexpensive way to lift roofs. Jacks are adjustable for setting homes with varying pitches up to 7/12 from the ground. Adjustable from 11'6" to 18' for setting homes with a pitch up to 5/12. For pitches up to 7/12, an extension tube is provided giving jack adjustment up to 21'6". Comes with:

- 1) 12" x 12" base plate
- 1) 1500 Lb., 2-way brake winch w/cable
- 1) Steel pulley with holder
- 1) 4' lifting bracket
- 1) Roller jacking foot
- 1) 3-1/4" inside pole, 10' long
- 1) 3-1/2" outside pole, 10' long
- 1) Extension tube, 4' long

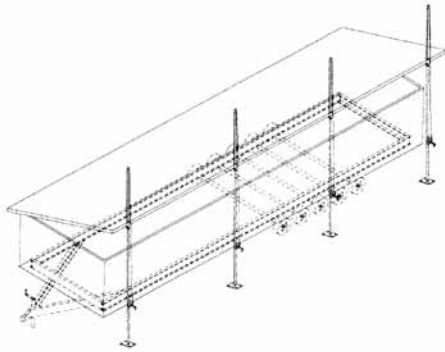

0410155 RJ-1000G;
 1000 lbs. load cap. per jack.
 Jack weight: 95 lbs.
 Tubing O.D. = 3.5"
 Tubing I.D. = 3.25"



- ◆ 1/2" 100% recycled polyethylene plastic
- ◆ Virtually indestructible, even in harsh conditions
- ◆ Double-sided, skid and slip resistant
- ◆ Low cost alternative to fiberglass mats
- ◆ Easily portable
- ◆ Maintenance free

Get vehicles and equipment over lawns, through mud and across soft terrain while saving labor, bog-down time, towing charges and ground restoration fees—perfect for set-ups.

0265301 2' x 4' **0265303** 2' x 8'
0265302 2' x 6' **0265304** 4' x 8'

Blocks

Bundled with heavy bailing wire.



Pressure-Treated Blocks

1" x 8" x 16"

0265422 10/Bundle, 60/Skid

0265455 20/Bundle

2" x 8" x 16"

0265423 5/Bundle, 60/Skid

0265457 10/Bundle

Untreated Blocks

1" x 8" x 16"

0265428 10/Bundle

0265401 Oak; 10/Bundle

2" x 8" x 16"

0265426 5/Bundle

0265402 Oak; 5/Bundle

Dip-Treated Blocks

0265416 2" x 8" x 16"; Oak; 5/Bundle

0265415 1" x 8" x 16"; Oak; 10/Bundle

Wedges

Pressure-Treated Wedges

0265433 4"; 80/Bundle, 28/Skid

0265436 4"; 100/Bundle

Dip-Treated Wedges

0265425 3"; 30/Bundle

0265411 4"; 30/Bundle



Untreated Wedges

0265424 3"; 30/Bundle

0265400 Oak 3"; 30/Bundle

0265420 4"; 30/Bundle

0265403 Oak 4"; 30/Bundle

Not Stocked at All Locations Due to Varying State Codes and Regulations.
Ask your rep which product is right for your needs.

Specifications Subject to Change without Notice



The OTI Plastic Wedge

Benefits: No Slip Serrated Edges, Impact Resistant, Packaged Loose, Made from Recycled Materials.



0265220 200/Bag 3.5" x 6" x 1"

OTI Cap Board



For use on all mobile and manufactured homes, including HUD approved homes and modular housing.
Patent #D517.702



Benefits: Non-Slip Surface, UV Tested & Approved, Non-Porous (Not Affected by Freeze or Thaw) Tested & Approved, Environmentally Safe, Made from Recycled Materials.

Product #	Size	Maximum Load Capacity (lbs)
0265215	1" x 8" x 16"	8,000
0265216	2" x 8" x 16"	8,000

Outdoor Improvements
Anchors & Set-Up Material

Doors & Windows

Coatings & Cleaners

Appliances

Tools & Hardware

Carpet & Flooring

Electrical

Plumbing

Towing & Safety

Heating & Cooling

Electronic Water Level

Easy, accurate digital leveling for mobile homes.

- ◆ Totally sealed; just check fluid monthly
- ◆ Scale reads in inches and tenths
- ◆ Typically will level to .2" (1/5") over entire radius
- ◆ Fluid is safe to sub-zero temperatures (red RV antifreeze)
- ◆ Includes: 100' tubing, storage reel

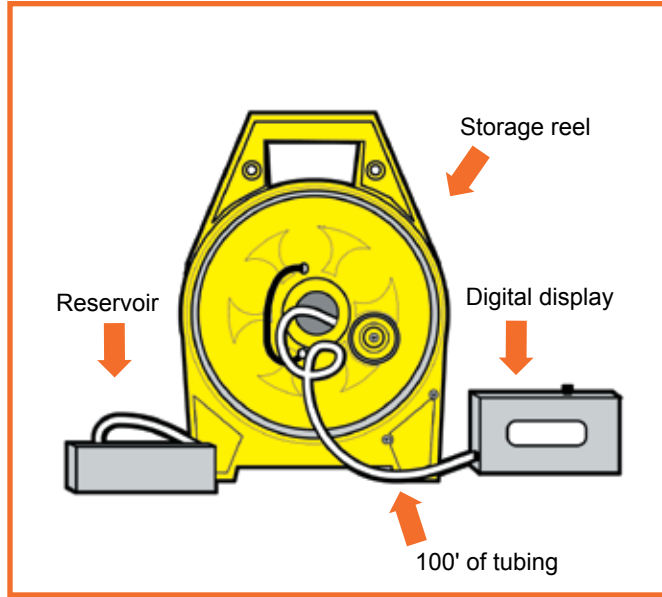

To Use:

1. Place reservoir end (square block marked "THIS END UP") on solid surface such as a concrete block near one end of the home.
2. Place the display on the bottom lip of the frame where you want to start and level the remainder of the frame to its reading.

0380075

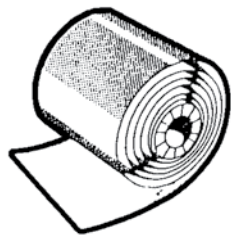

Roof Cap Flashing

- 0200055 Galvanized, 12" x 60'
- 0200056 Aluminum, 10" x 50'
- 0200057 Galvanized, 10" x 50'
- 0200058 Aluminum, 10" x 70'
- 0200059 Galvanized, 8" x 50'

Re-Usable Ridge Cap

The best alternative for retail lot set-up. Made from high density woven polyethylene providing rugged durability. Lightweight material makes for easy one-man installation using wood screws. The economical solution for temporary home protection.



- 0200050 10" x 70'
- 0200051 24" x 70'
- 0200052 10" x 80'
- 0200053 24" x 80'
- 0263075 Wood Screws w/Washers;150/Box

B-18

Adjustable FHA Building or Basement Columns by GrowCo

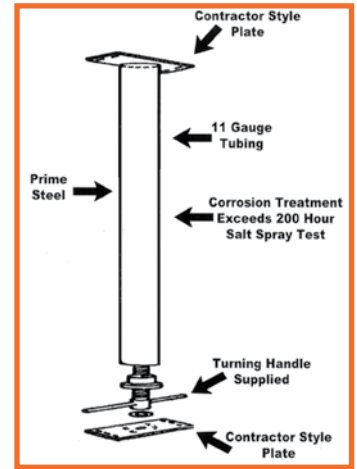

- > All building columns meet the specifications of ICC Evaluation Services
- > Columns are available in 3", 3-1/2" and 4" diameter, 11 gauge material; lengths to 12'; adjustable or fixed lengths
- > All tube and component parts are manufactured in-house assuring a consistently high quality manufactured product
- > GrowCo offers a number of top-plate configurations to adapt to the material supported (Wood, Steel, LVL, etc.)
- > Columns are powder coated to provide a rust resistant finish
- > Crawl space and special length adjustable columns are available upon request
- > All column labels have a scannable UPC for inventory control
- > All GrowCo columns are constructed from materials that are made in the USA

Product #	Adjustable	Gauge	Min. FHA Load Capacity
0120450	7' 6" - 7' 10" x 3"	11	14,300 lbs.
0120451	7' 9" - 8' 1" x 3"	11	14,300 lbs.
0120452	8' 9" - 9' 1" x 3"	11	13,100 lbs.
0120453	8' 9" - 9' 1" x 4"	11	13,700 lbs.
0120455	8' 6" - 8' 10" x 3"	11	13,100 lbs.

Rumble Buttons



1-1/8" dia. steel washer with neoprene backing for the best roof leak resistance. Suggested spacing is 16" x 24". For #8 Screws. Clear Box. 4/ctn

- 0263027 500/Box
- 0263028 100/Box

Pacstrap Polyester Cord Strapping

No splinters... no sharp edges... easy to transport and store... and PACSTRAP can be stapled through, too!

- ◆ High tensile polyester yarn out performs steel and polypropylene
- ◆ Absorbs sudden impacts that might break steel strapping
- ◆ Doesn't stretch out of shape like polypropylene
- ◆ Unaffected by moisture; will not rot, rust, discolor or mildew
- ◆ Impervious to extreme temps
- ◆ Resistant to UV light and many chemicals and solvents
- ◆ Soft and pliable, so it's safe and easy to use; no recoil when cut, no sharp edges or corners
- ◆ Reusable or easily disposed
- ◆ Tie by hand or secured with buckle or a seal
- ◆ Can be stapled through

0265030 1/2" x 3900'

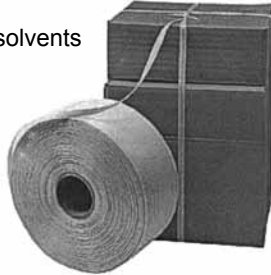

**PERFECT FOR CLOSING OFF MOBILE HOME SEGMENTS...
REPLACES FURRING STRIPS WITH EASE!**

Lathes (Furring Strips)

Wooden strips used to attach plastic covers, etc. to homes.



- 0265025** 2" x 2" x 8'
- 0265026** 2" x 2" x 3'
- 0265027** 1" x 2" x 8' (25/Bundle)
- 0265028** 1" x 2" x 8'

Vapor Barrier

Clear Plastic Vapor Barrier

0265017	8' x 100'	6 ml Vapor Barrier
0265016	10' x 100'	6 ml Vapor Barrier
0264996	16' x 100'	6 ml Vapor Barrier
0265018	10' x 100'	10 ml Vapor Barrier
0265019	12' x 100'	10 ml Vapor Barrier
0264998	14' x 100'	10 ml Vapor Barrier

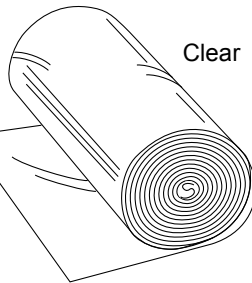

Clear

Black Plastic Vapor Barrier

0264997	10' x 100'	6 ml Vapor Barrier
0265005	14' x 100'	6 ml Vapor Barrier
0265004	16' x 100'	6 ml Vapor Barrier
0265002	20' x 100'	6 ml Vapor Barrier
0265001	24' x 100'	6 ml Vapor Barrier
0265000	16' x 150'	6 ml Vapor Barrier
0265007	20' x 150'	6 ml Vapor Barrier

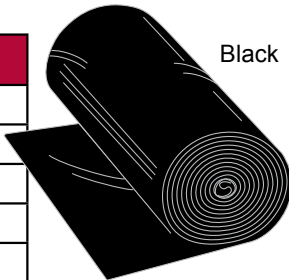

Black



Section 3285.505 Crawlspace Ventilation - A crawlspace with skirting must be provided with ventilation openings. The minimum net area of ventilation openings must not be less than one sq ft for every 150 sq ft of the home's floor area. The total area of ventilation openings may be reduced to one sq ft for every 1,500 sq ft of the home's floor area, where a uniform 6 mil polyethylene sheet material or other acceptable vapor retarder is installed, according to 3285.204, on the ground surface beneath the entire floor area of the home.

Section 3285.204 Ground Moisture Control - The HUD code does not permit any voids or tears in the ground vapor retarder, requires all joints to be overlapped at least 12", and allows the vapor retarder to be installed around or over footings and other obstructions. The final rule requires the thickness of the vapor retarder to be a minimum of 6 - mil polyethylene sheeting. All enclosed and skirted areas are to be provided with a ground vapor retarder, except in arid regions and areas for open porches, decks and recessed entries.

White Close-Off Film

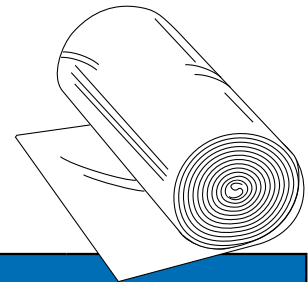

White Close-Off Film

for secondary moves

0265003	12' x 120'	6 ml Close-Off Film
0265009	16' x 100'	6 ml Close-Off Film
0265006	14' x 300'	5 ml Close-Off Film
0265008	16' x 150'	6 ml Close-Off Film

White Close-Off Tape



5.5 utility grade polyethylene patching and repair tape for close-off film and general use. White.

- 0360725** 2" x 36 yards
- 0360726** 4" x 36 yards

Bottom Board

Constructed of one-ply polyethylene fabric for physical strength coated with black polyethylene film for a positive moisture barrier. **(Not self-adhesive.)**

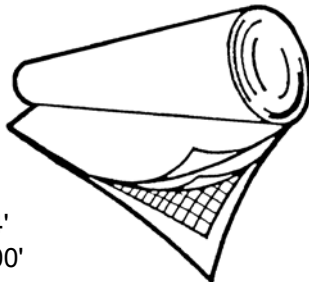

- 0360000** 14' x 70'
- 0360001** 14' x 4'
- 0360010** 30" x 100'
- 0360007** 4' x 600'
- 0360008** 16' x 80'

Center-Seal

Centerline Insulator

Flexible insulating foam core

Foam is completely sealed inside a high-strength vapor barrier sheathing



2-Ply flanges make it easy to fasten Centers-Seal to the mating surface around perimeter of home.

- ◆ Provides a continuous seal
- ◆ Withstands exposure to the elements
- ◆ Does not blow off during transport
- ◆ Lasts even through repeated resets
- ◆ Eliminates customer concern over visible daylight
- ◆ Superior insulation for better energy efficiency and protection against rodents and insects
- ◆ Compact, lightweight and easy to handle; no skin irritation
- ◆ Needs no special tools - staples or tucks
- ◆ Installs faster than fiberglass, spray foam, etc.
- ◆ Unlike other materials, does not absorb moisture but blocks it, protecting home against structural and cosmetic damage

0265055 2" x 375'

Black Bottom Board Economy Tape

Specifically made for patching and splicing bottom board paper used in mobile homes. Excellent adhesion to wood, metal and plastic. Tears and hangs straight, no curl. Certified to meet HUD specifications of the Office of Mobile Home Standards and approved and certified for HVAC applications. 2" x 60 yards.



0360703 24/Ctn.

Premium Bottom Board Tape

Seal-Tite #620 with high tack – a heavier adhesive layer, twice the thickness of economy cloth tapes, for jobs that require exceptionally high peel and shear strength. 2" x 36 yards/roll.



0360704 24/Ctn.

FoamSeal[®]

Multi-purpose ridged sill plate gasket provides resilient sealing—perfect for setup of double wide mobile homes.

- ◆ Fills gaps against air infiltration
- ◆ Easy to install—no special tools
- ◆ Resists moisture penetration to interior
- ◆ Helps seal out insects

0265050 5.5" x 50' Roll



Sta'-Put Spray Adhesive

Works well on bottom board, vinyl tops, metal or vinyl trim, styrofoam, foam rubber, glass, plastics and much more. Gives high solids, water-resistant bonds offering quick tack, non-wrinkling and flexibility.

- 0110250** 16 oz.; 12/Ctn.
- 0110253** 40# Canister

Sta'-Put II Spray Adhesive

Spray directly onto polystyrene safely with no melt-down. Ready to bond in four minutes. Water resistant. Especially formulated for styrofoam.

0110252 13 oz.; 12/Ctn.



Sta'-Put High Temp Adhesive

For use where high temperatures are an issue. Flame resistant to approx. 225° F. Non-flammable after tacked. Welds onto surface after about one minute. Not as tacky to the touch, but offers a much stronger bond once cured.

0110256 12/Ctn.

Sta'-Put II Remover

Simplifies clean-up of overspray and removes bonded materials. Virtually no residue. Compatible with most surfaces. Not recommended for paper-printed wallpaper without vinyl coating.

0110254 15 oz.; 12/Ctn.

FLEX-PATCH

Bottom Closure Mending Material

Flex-Patch™ is a woven polyethylene fabric, solid-coated with a specially formulated, very aggressive adhesive. An easily removed paper release is laminated to the fabric. With ordinary scissors, any size or shape patch or strip can be cut to fit the damaged area. All size rolls are shipped in a poly sleeve, and 100' rolls are individually boxed. Application instructions are packed with each roll.

- 0360002** 28" x 100'; 6 rolls/Ctn.
- 0360003** 28" x 50'; 10 rolls/Ctn.
- 0360004** 28" x 25'; 20 rolls/Ctn.

- * **Neat.** A Flex-Patch™ patch is almost invisible when used to repair damaged woven polyethylene bottomboards.
- * **Quick.** Simply cut the right size patch and peel off the paper release liner. In just seconds, the entire hole or tear is covered permanently!
- * **Waterproof.** Both the substrate and the adhesive are unaffected by moisture or water.
- * **Strong.** An attempt to remove the patch will result in destruction of the patched area.
- * **Permanent.** Neither the substrate or adhesive will deteriorate.
- * **Unaffected by Cold.** Flex-Patch™ can be applied in below-freezing temperatures and will hold regardless of the season.

Bottom Board Mending Kit

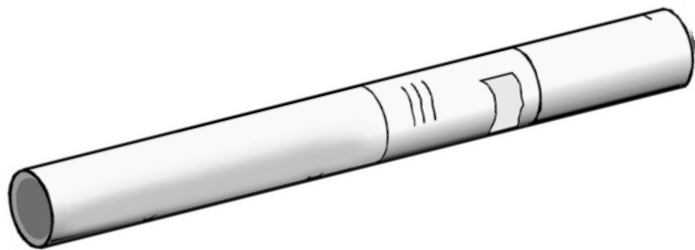

Ten sq. ft. (54" x 28") of Flex-Mend™ along with 20 sq. ft. (108" x 28") of woven polyethylene bottomboard (without adhesive) packed in a 2-1/2" diameter spiral tube. Repair small holes, tears and cuts by cutting patches from Flex-Mend™, or larger damaged areas where the original bottomboard is missing using bottomboard replacement material. Then, Flex-Mend™ can be cut into strips and applied as a tape to seal the un-coated bottomboard patch in place. Application instructions are printed on the outside of each tube.

- 0360005** Kit; 15 Kits/Ctn.
10 sq. ft. of Flex Mend and
20 sq. ft. of Bottom Board

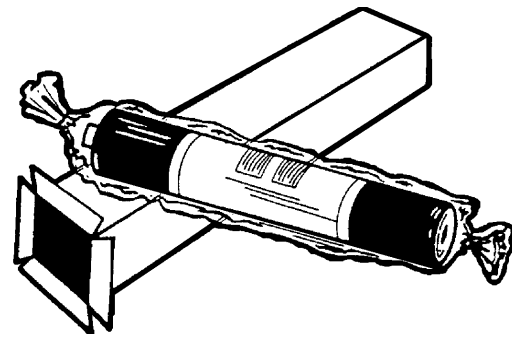

FLEX-PATCH Mending Tape



Easy-to-use tape form, perfect for small jobs. 4" x 180' Roll. Boxed.

0360006

ECONO-MEND Economy Mending Tape



Same as above, only 4" x 165' roll with no release paper. Boxed.

0360011 4" x 165'

Heating & Cooling

Towing & Safety

Plumbing

Electrical

Carpet & Flooring

Tools & Hardware

Appliances

Coatings & Cleaners

Doors & Windows

Anchors & Set-Up Material

Outdoor Improvements

Notes:

Lined area for handwritten notes.